

mask



mask

3x 2412b White
 1x 35480 White
 12x 22388 White
 10x 98138 White
 15x 25269 White
 4x 49307 White

2x 60479 Black
 1x 3028 Black
 2x 3021 Black
 1x 3031 Black
 1x 3036 Black
 3x 3666 Black
 4x 85984 Black
 2x 41764 Black
 2x 41748 Black
 12x 3023 Black
 2x 3832 Black
 2x 3032 Black
 7x 3795 Black
 2x 3034 Black
 2x 41747 Black
 2x 41765 Black
 2x 3009 Black
 7x 3795 Black
 2x 3032 Black
 1x 3034 Black
 2x 41747 Black
 2x 41765 Black
 1x 3001 Black
 2x 3024 Black
 2x 3032 Black
 1x 3034 Black
 2x 2456 Black
 15x 3794b Black
 2x 93606 Black

3x 41770 Black
 3x 41769 Black
 4x 3020 Black
 3x 43722 Black
 3x 43723 Black
 8x 3660 Black
 4x 6091 Black
 2x 87580 Black
 8x 3710 Black
 2x 24307 Black
 2x 26601 Black
 8x 61678 Black
 2x 24299 Black
 3x 3022 Black
 12x 13547 Black
 2x 33909 Black
 4x 3037 Black
 4x 99206 Black
 2x 3069 Black
 4x 2420 Black
 2x 51739 Black
 1x 3022 White
 1x 3020 White
 2x 27925 White
 2x 18674 White
 2x 27263 White
 2x 20953 White
 2x 18674 White
 2x 98138pb385 Yellow
 2x 4032 Red
 1x 3070 Red
 2x 3023 Red
 1x 3794b Red
 2x 4150 Red



1

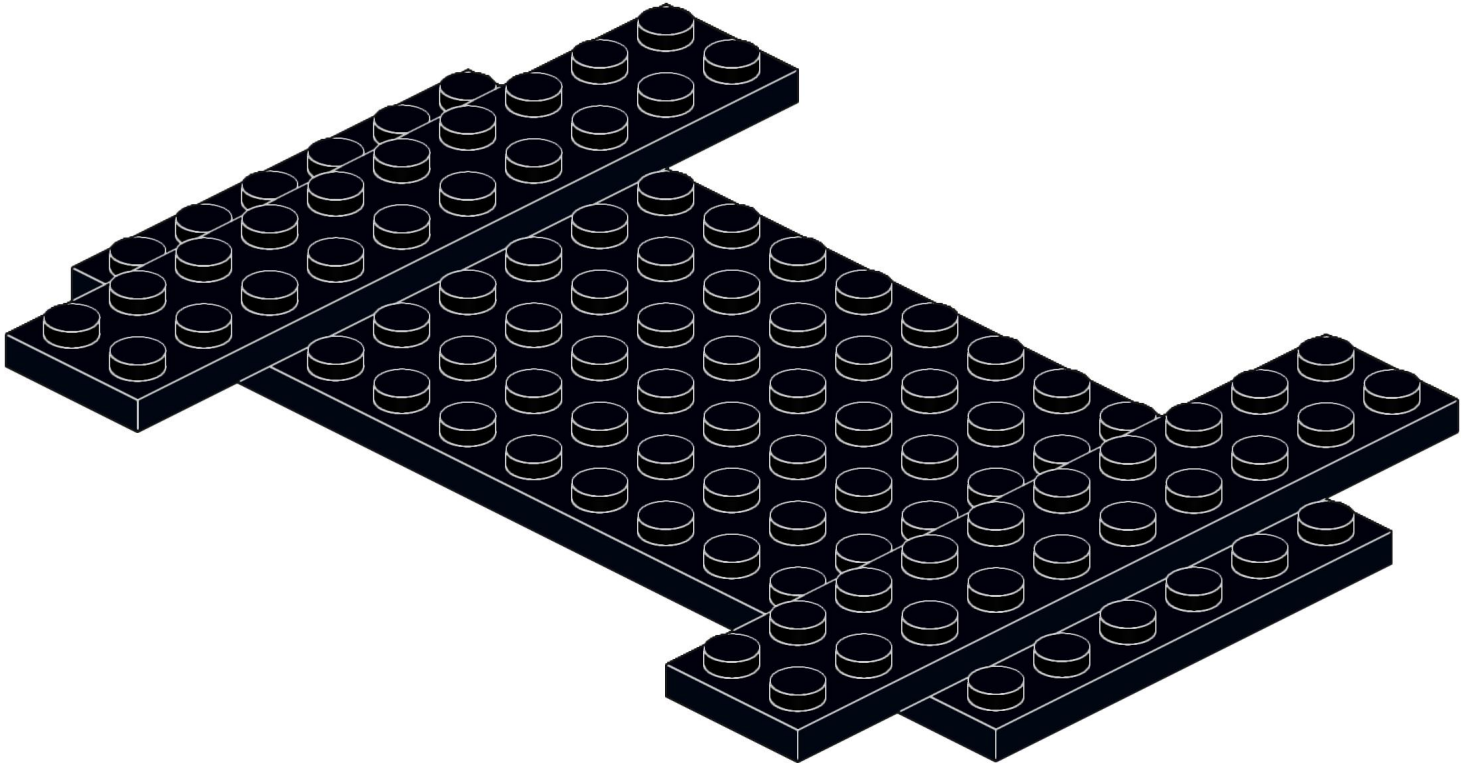
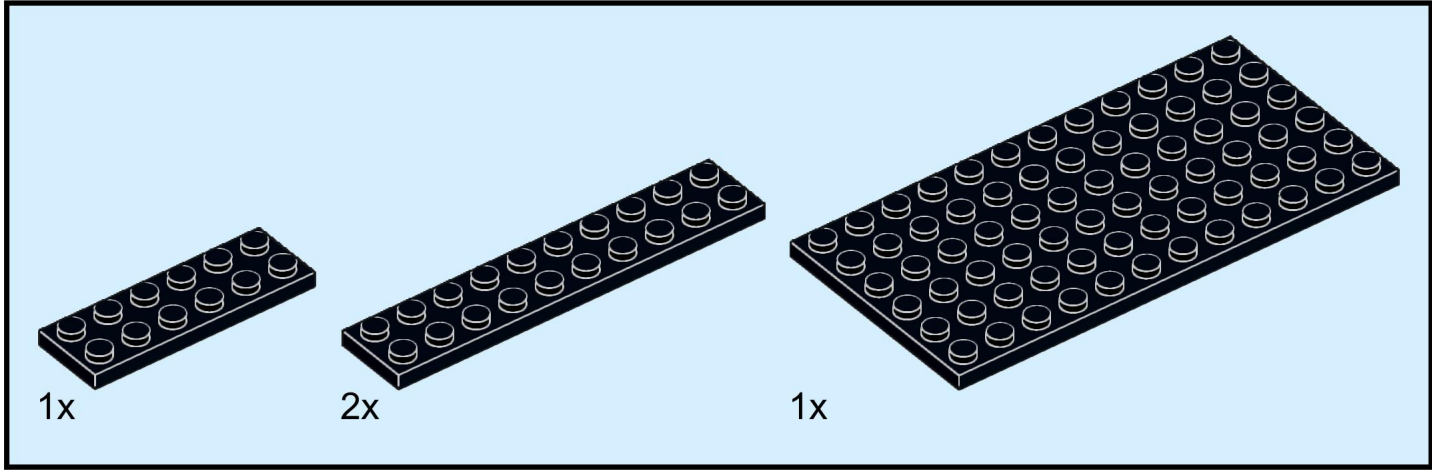

2

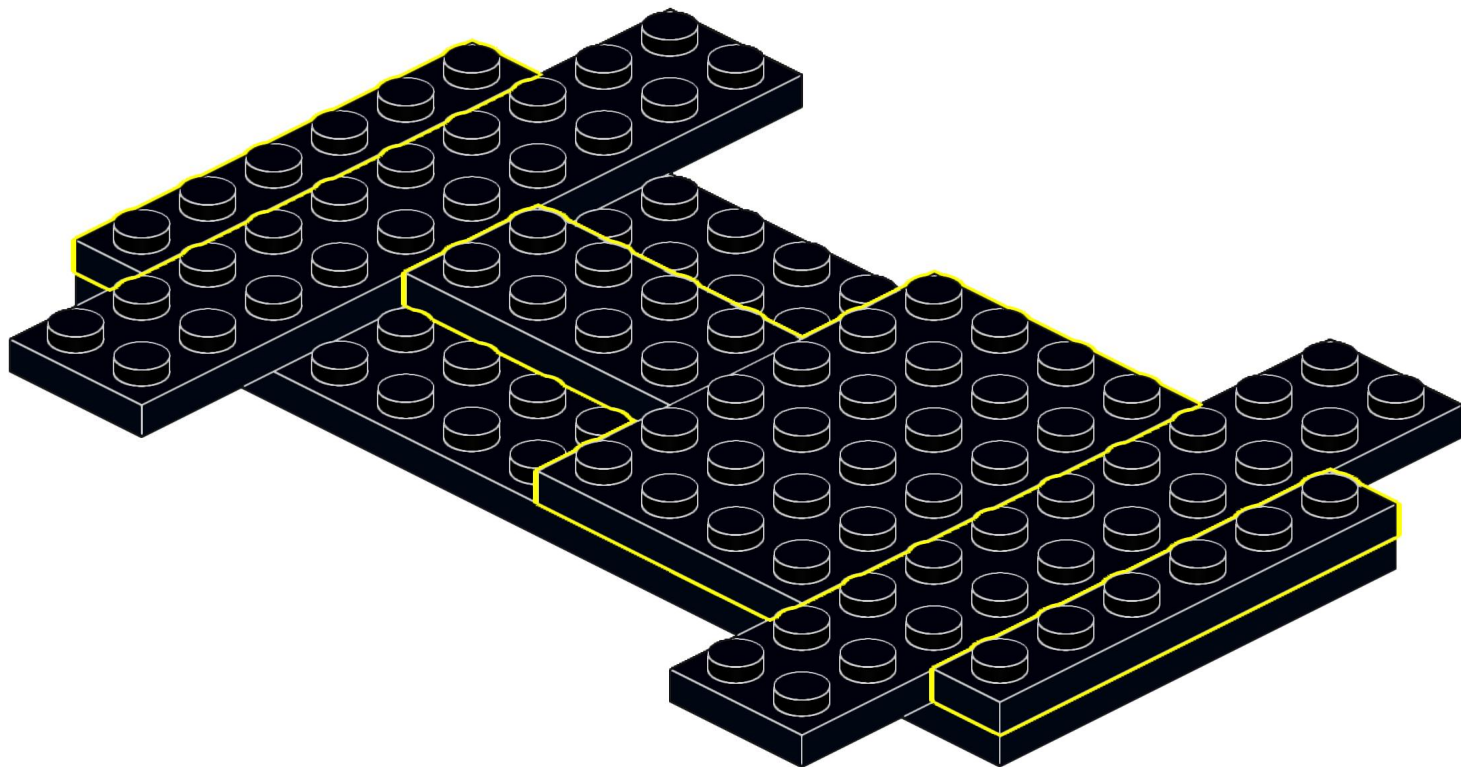
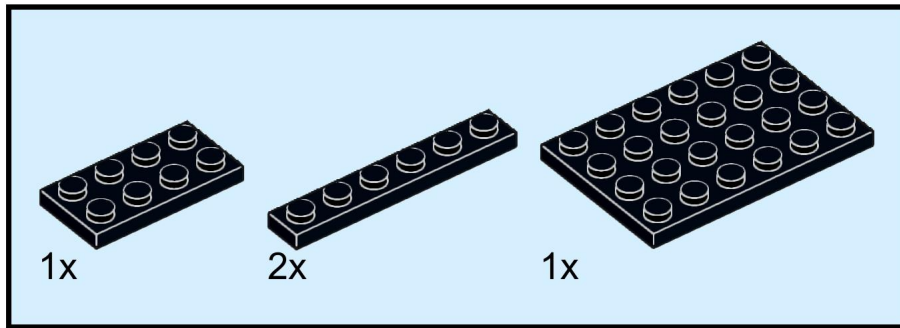

3

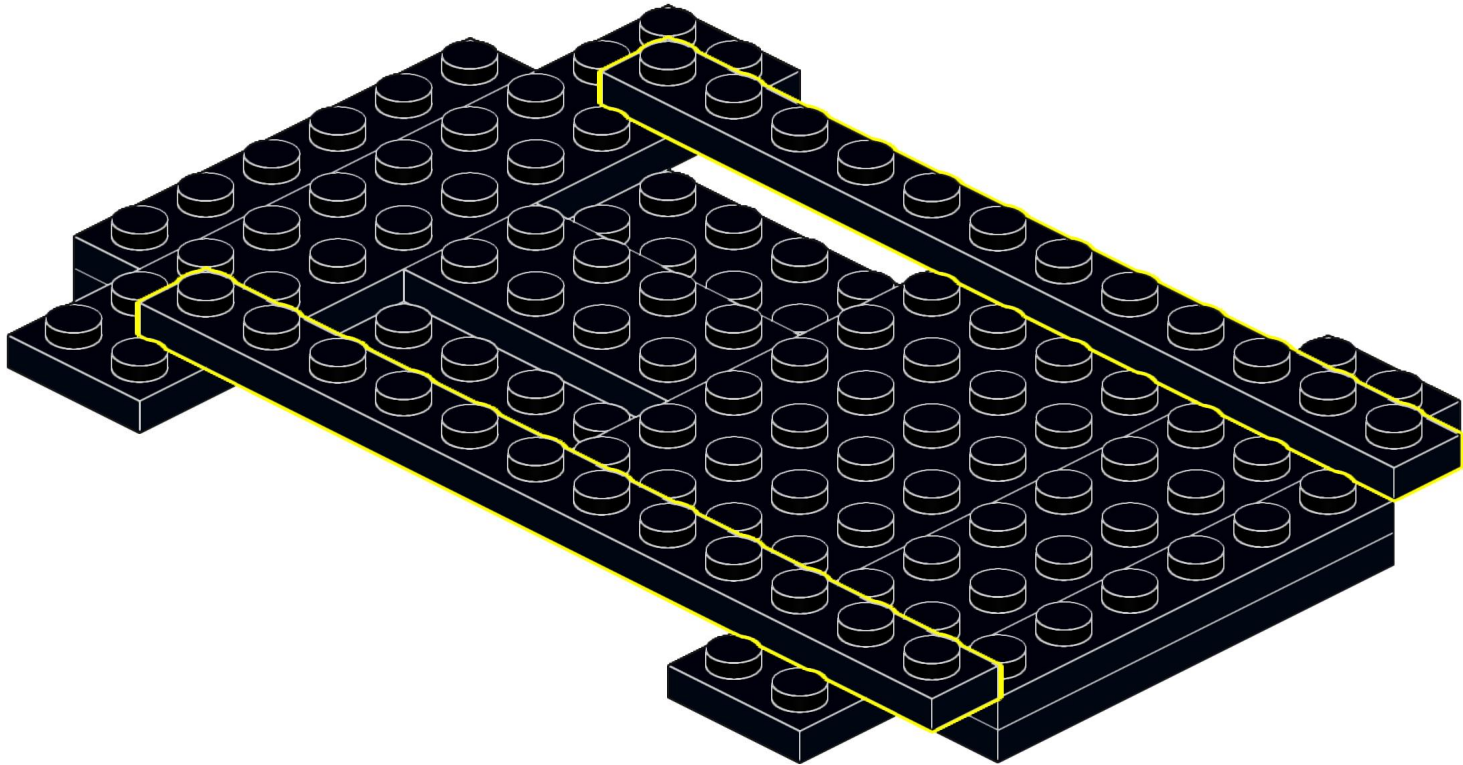
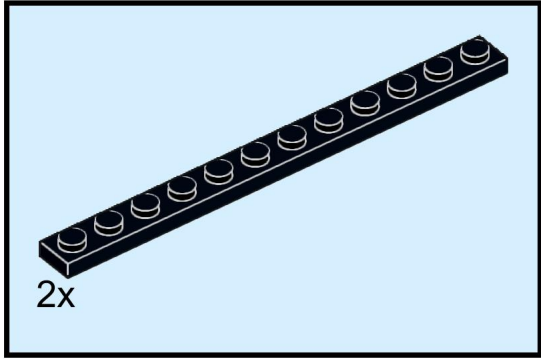

4

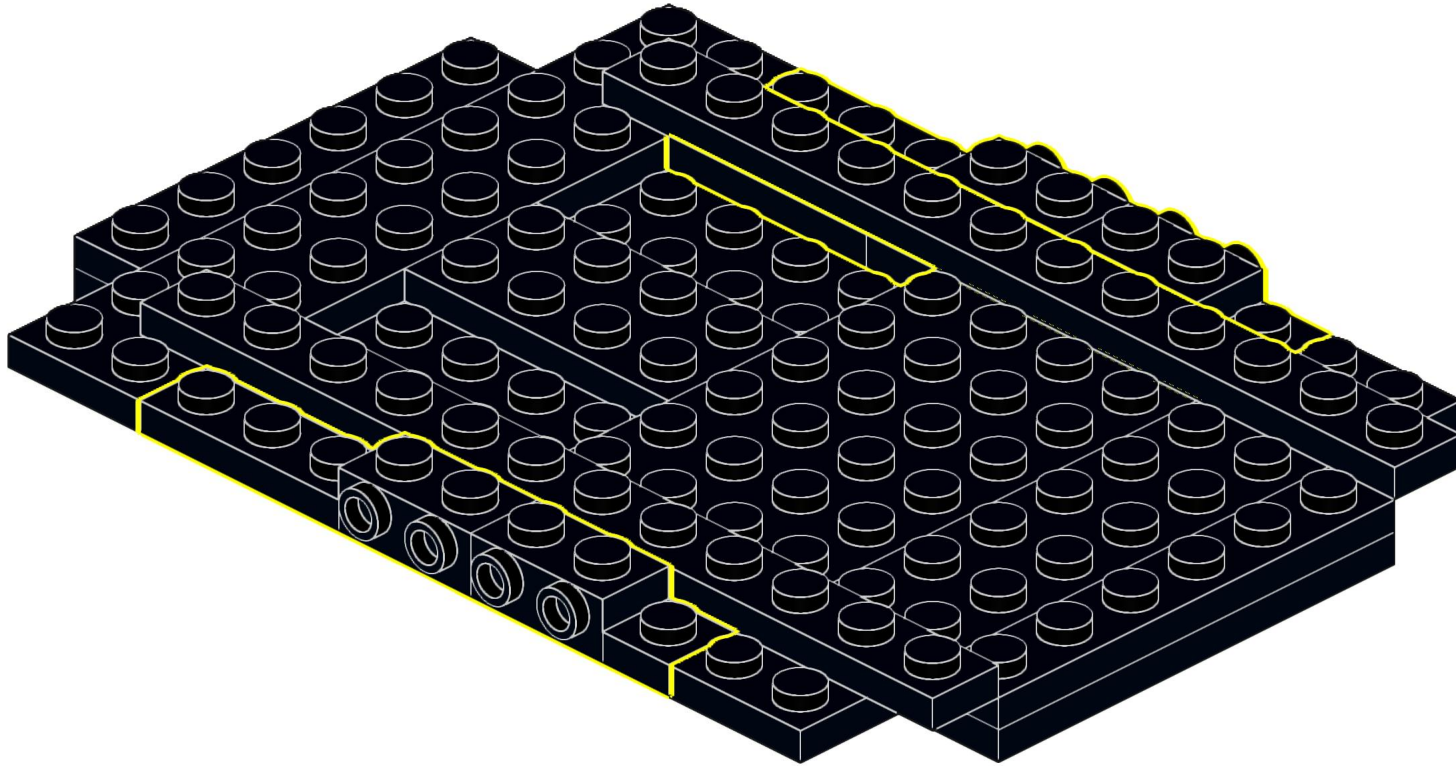
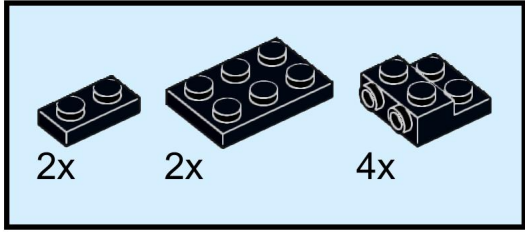

5

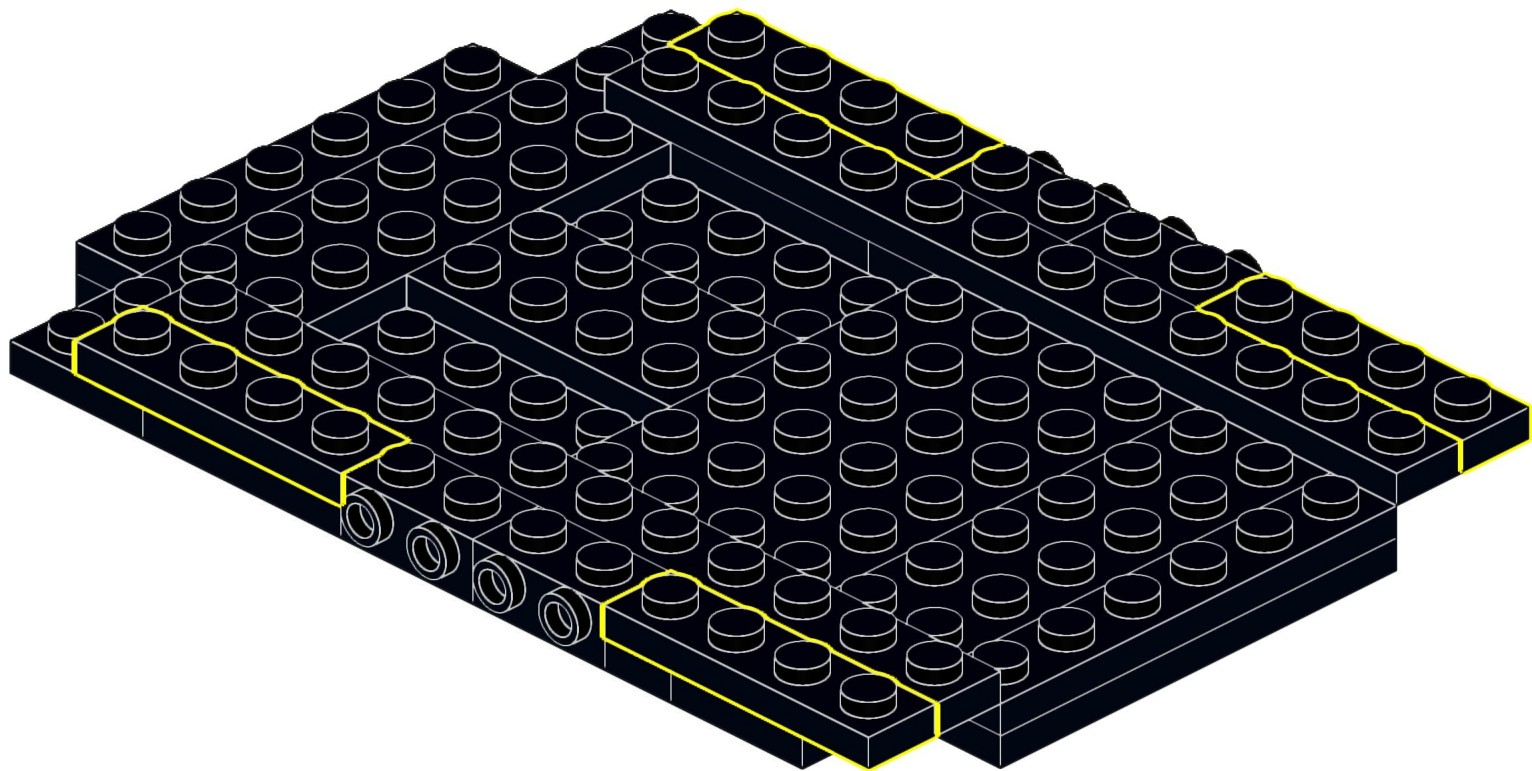
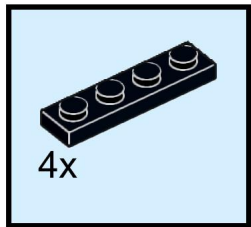

6

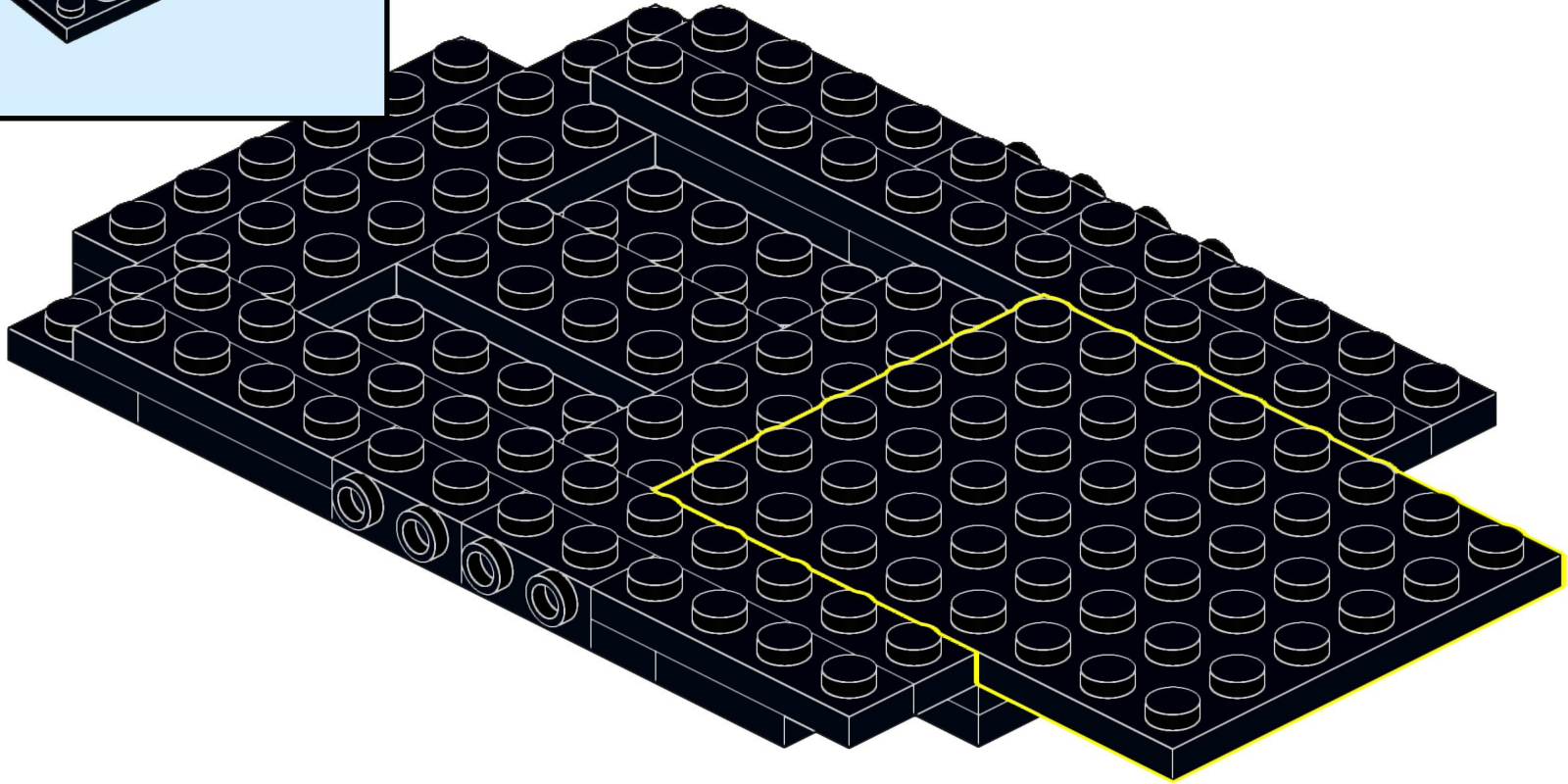
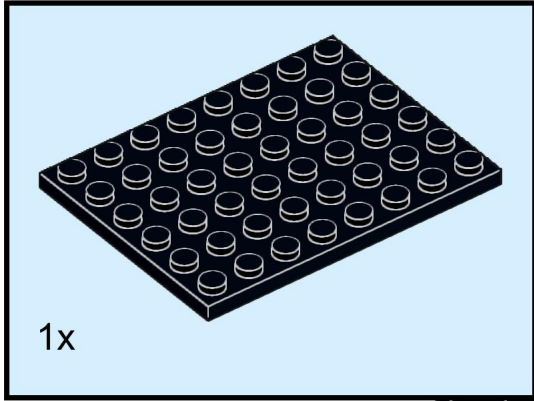

7

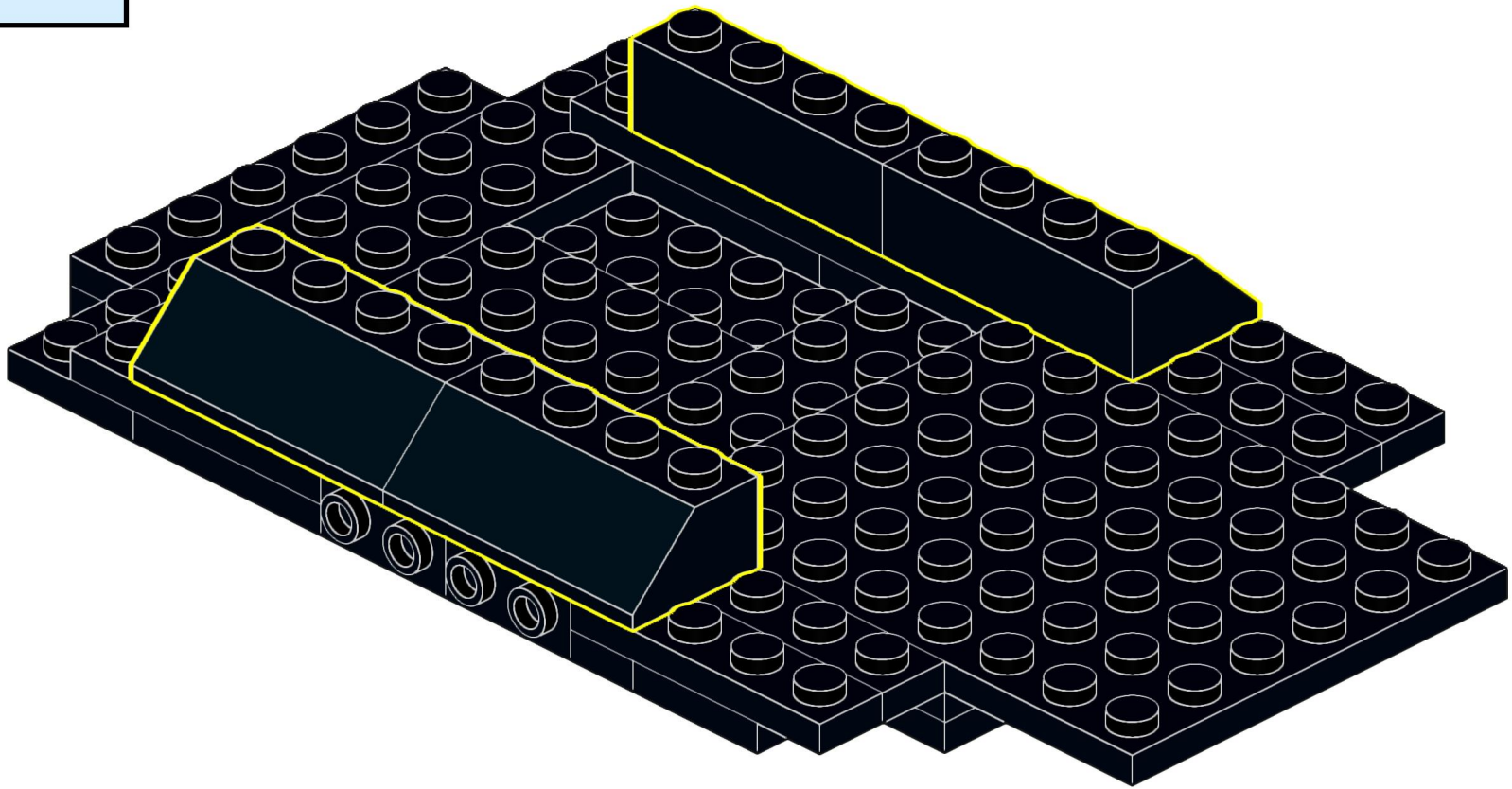
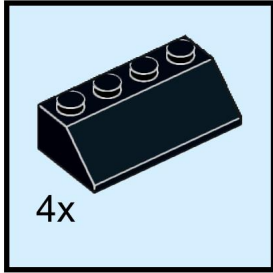

8

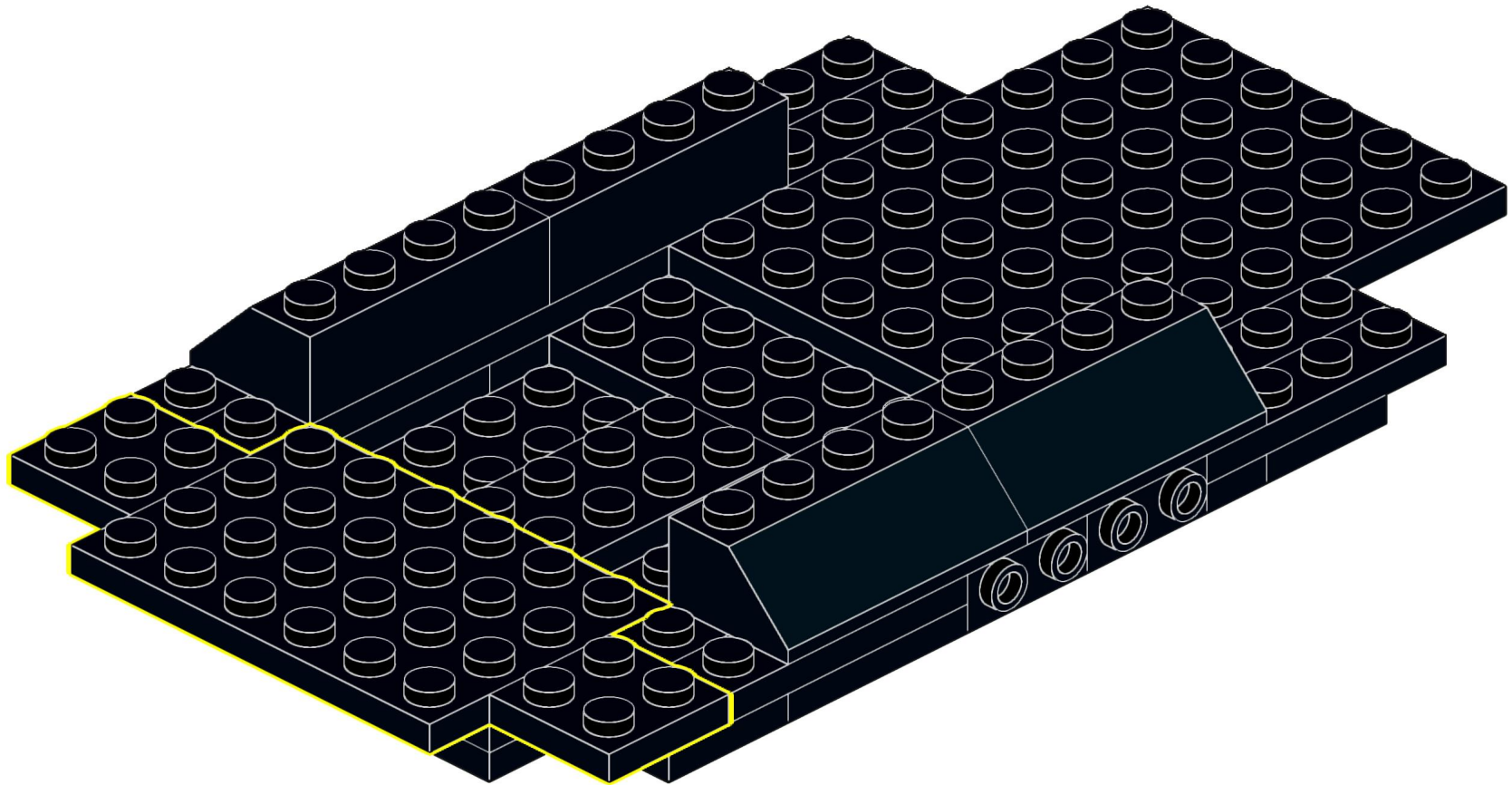
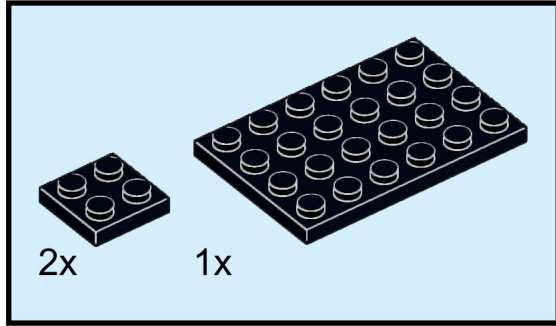

9

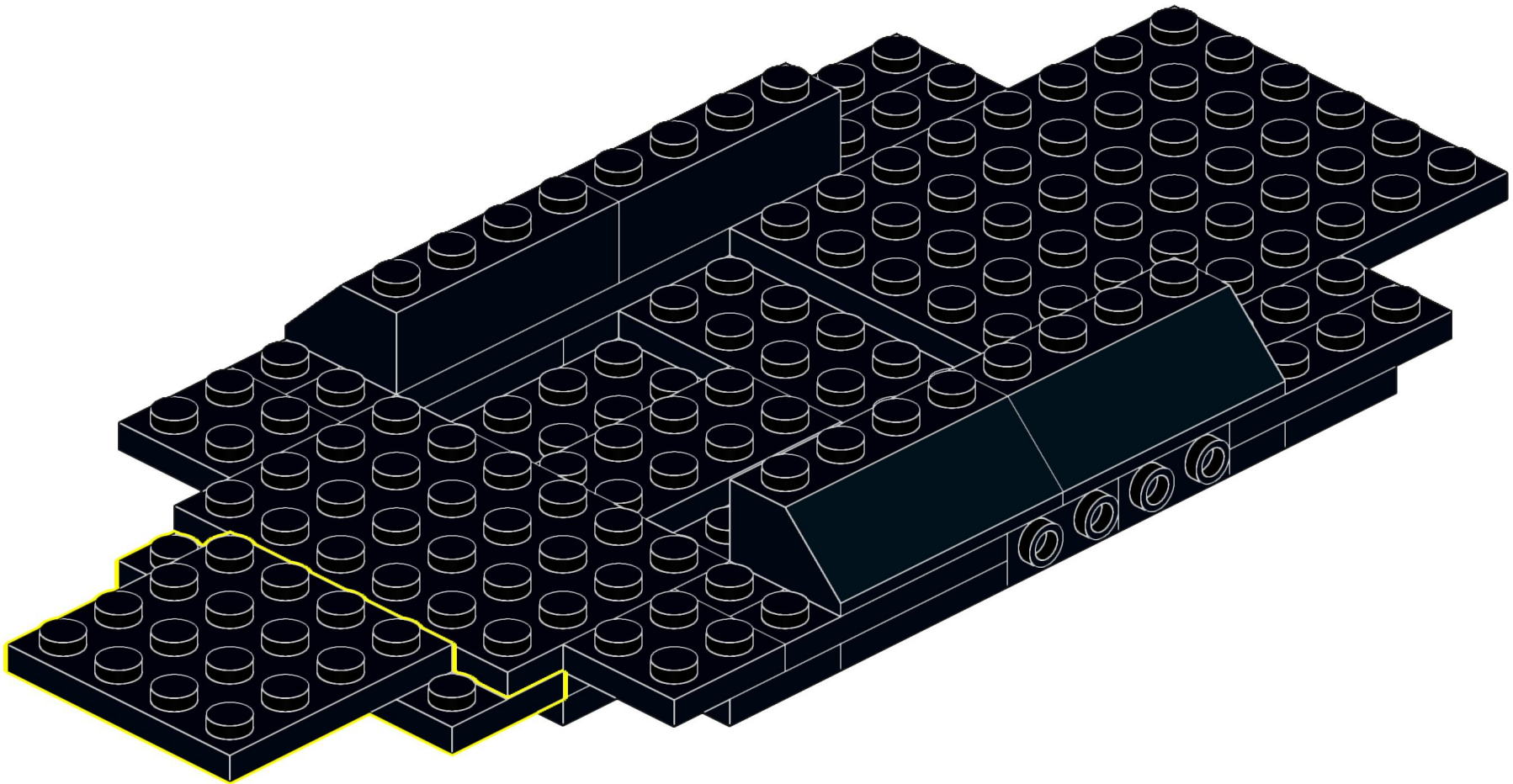
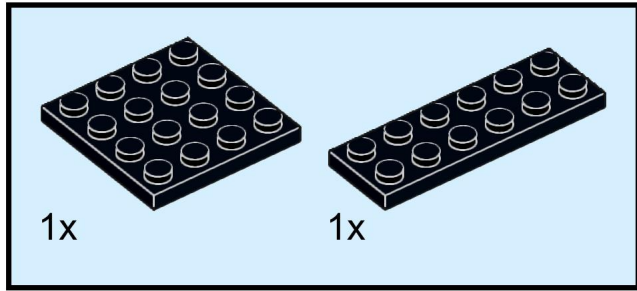

10

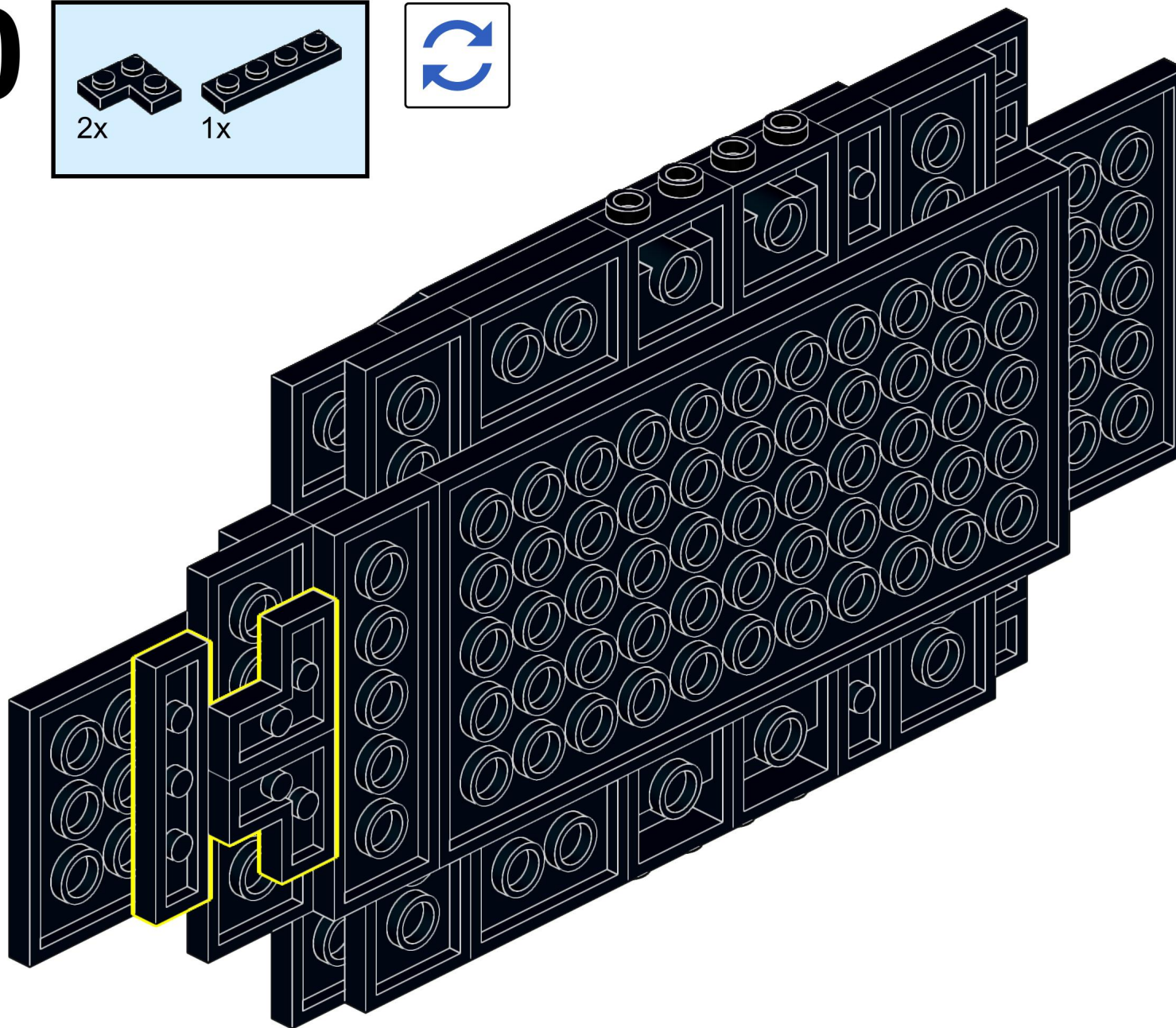
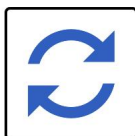
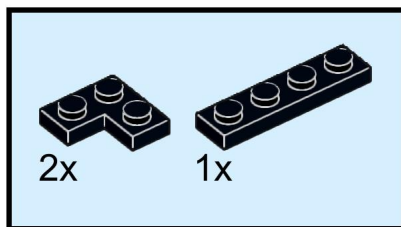

11

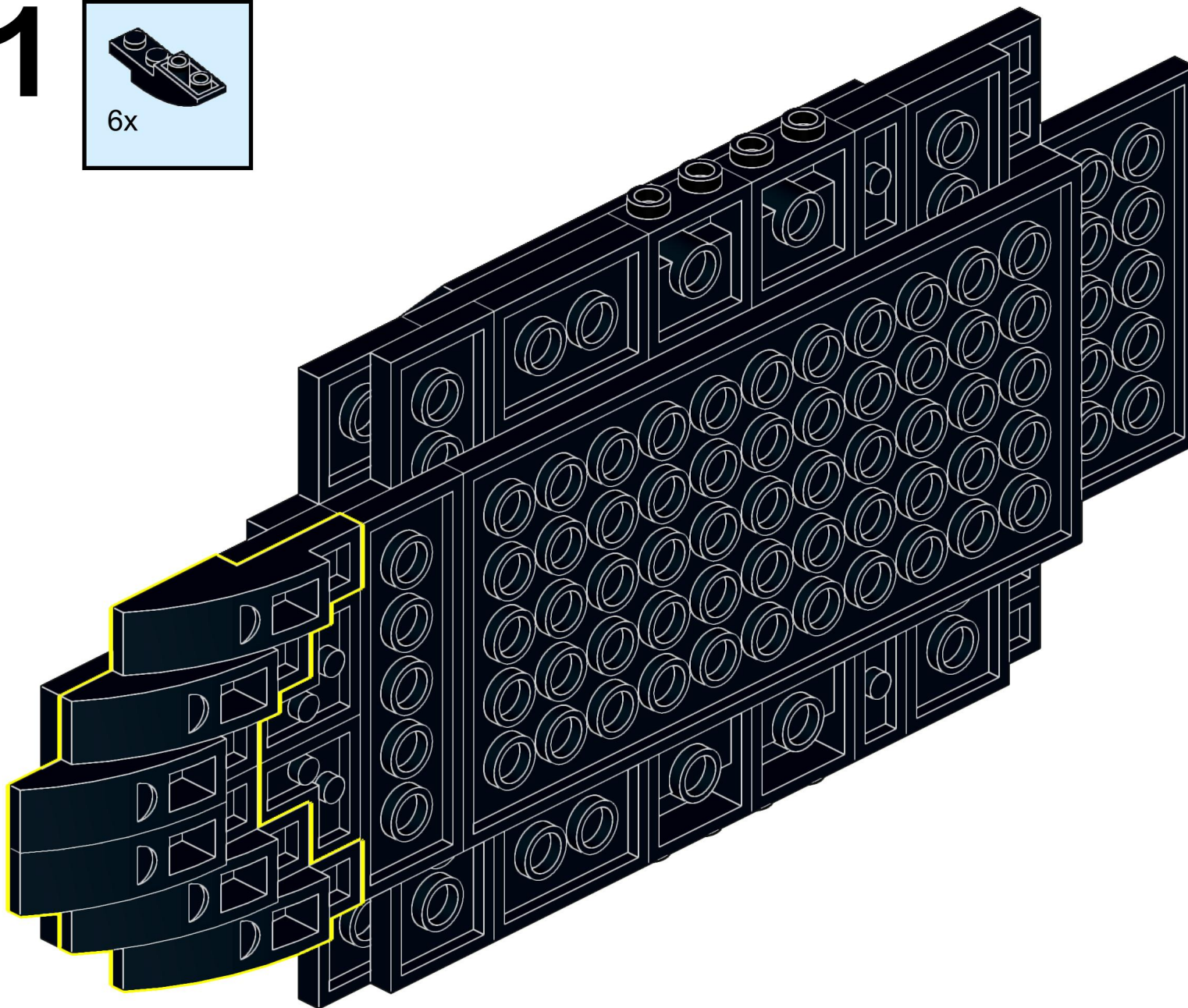
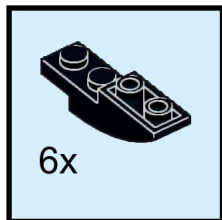

12

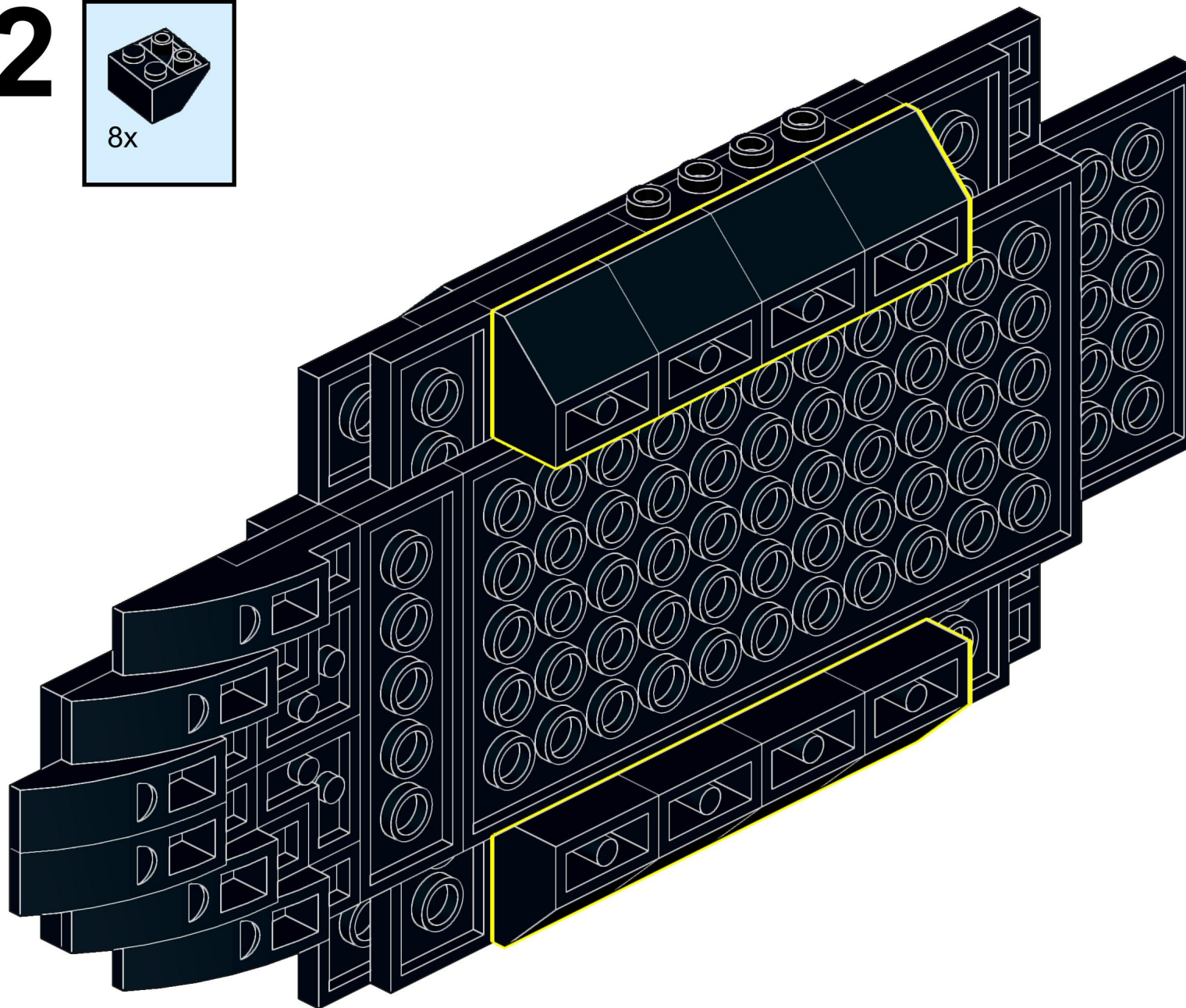
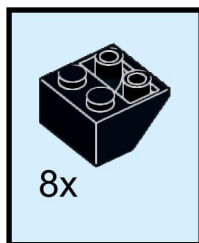

13

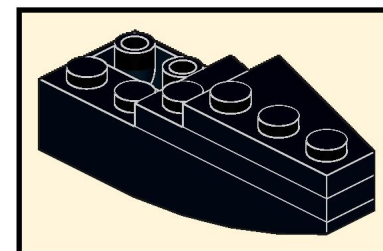
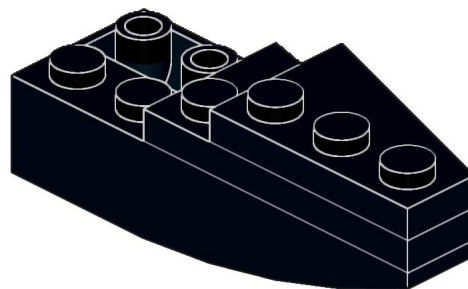
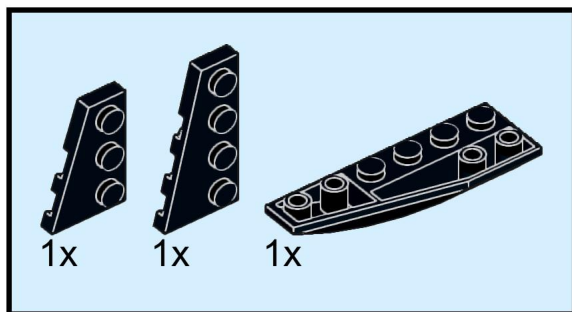

2x

14

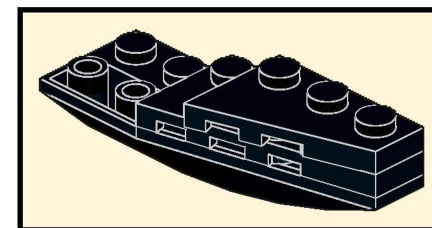
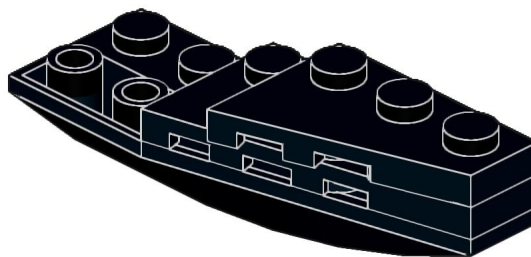
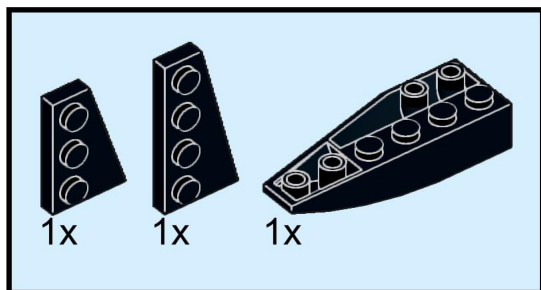

2x

15

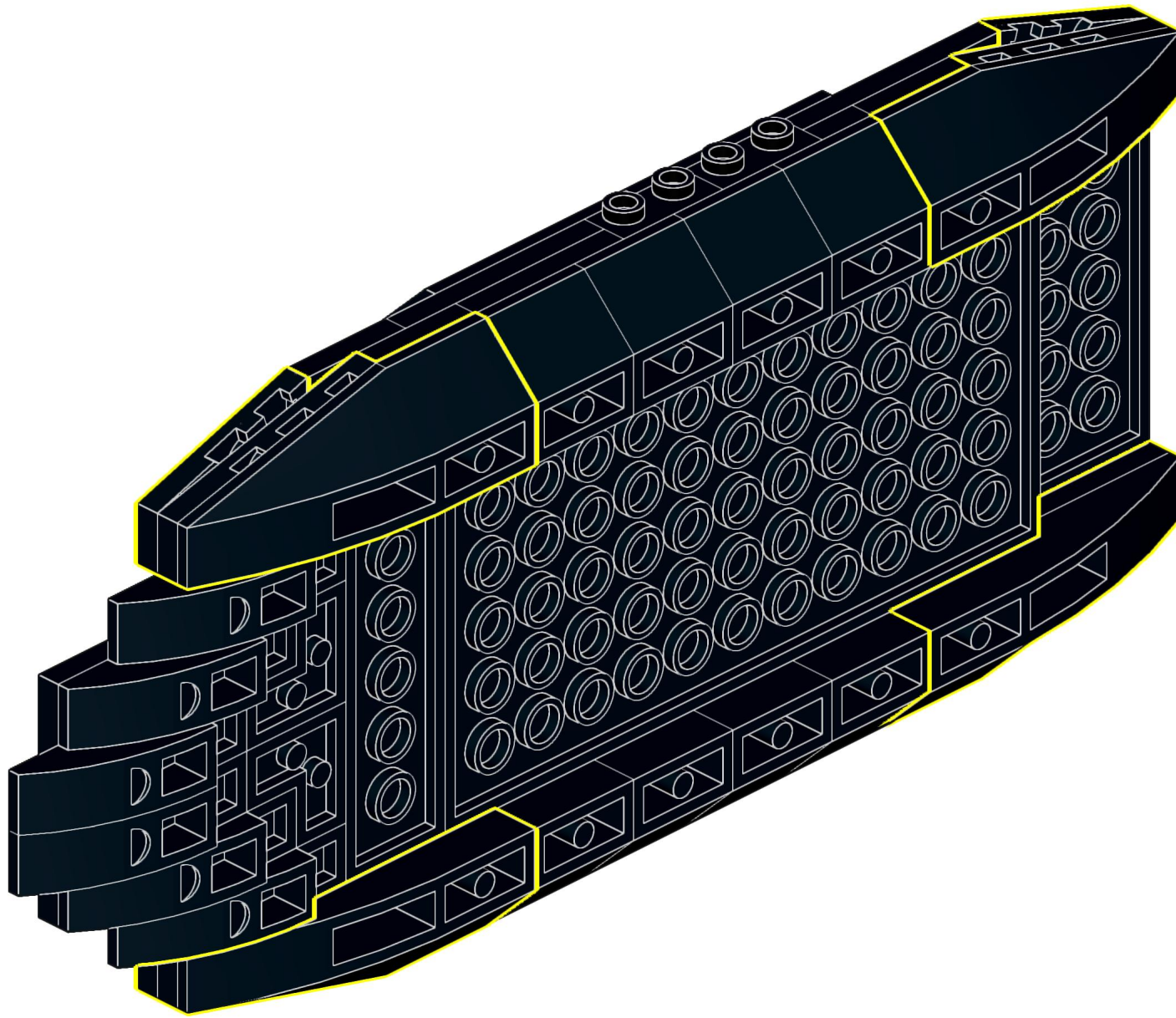

16

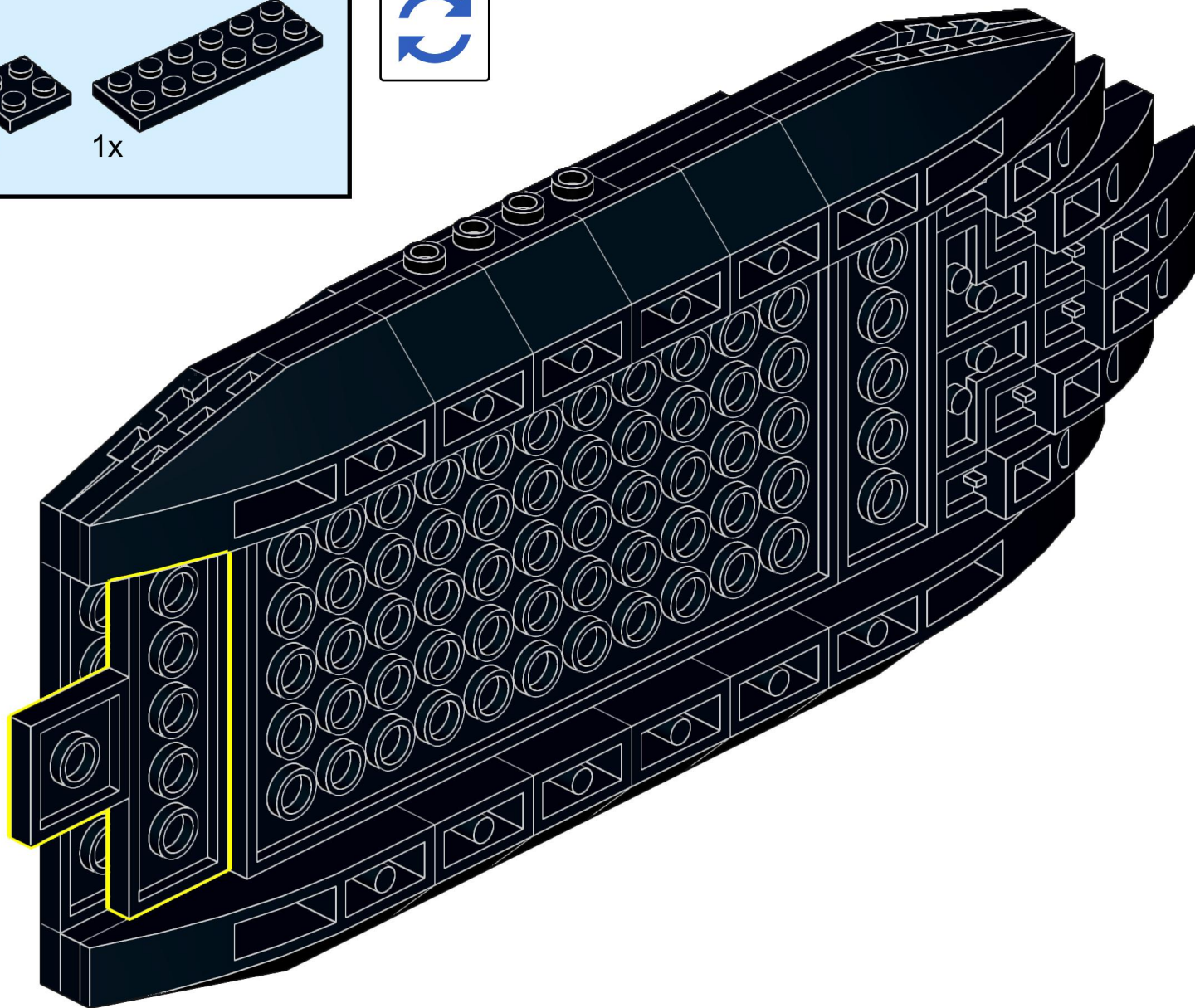
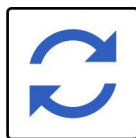
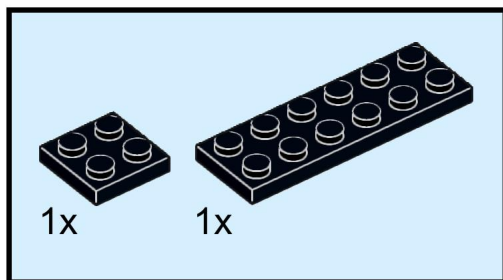

17

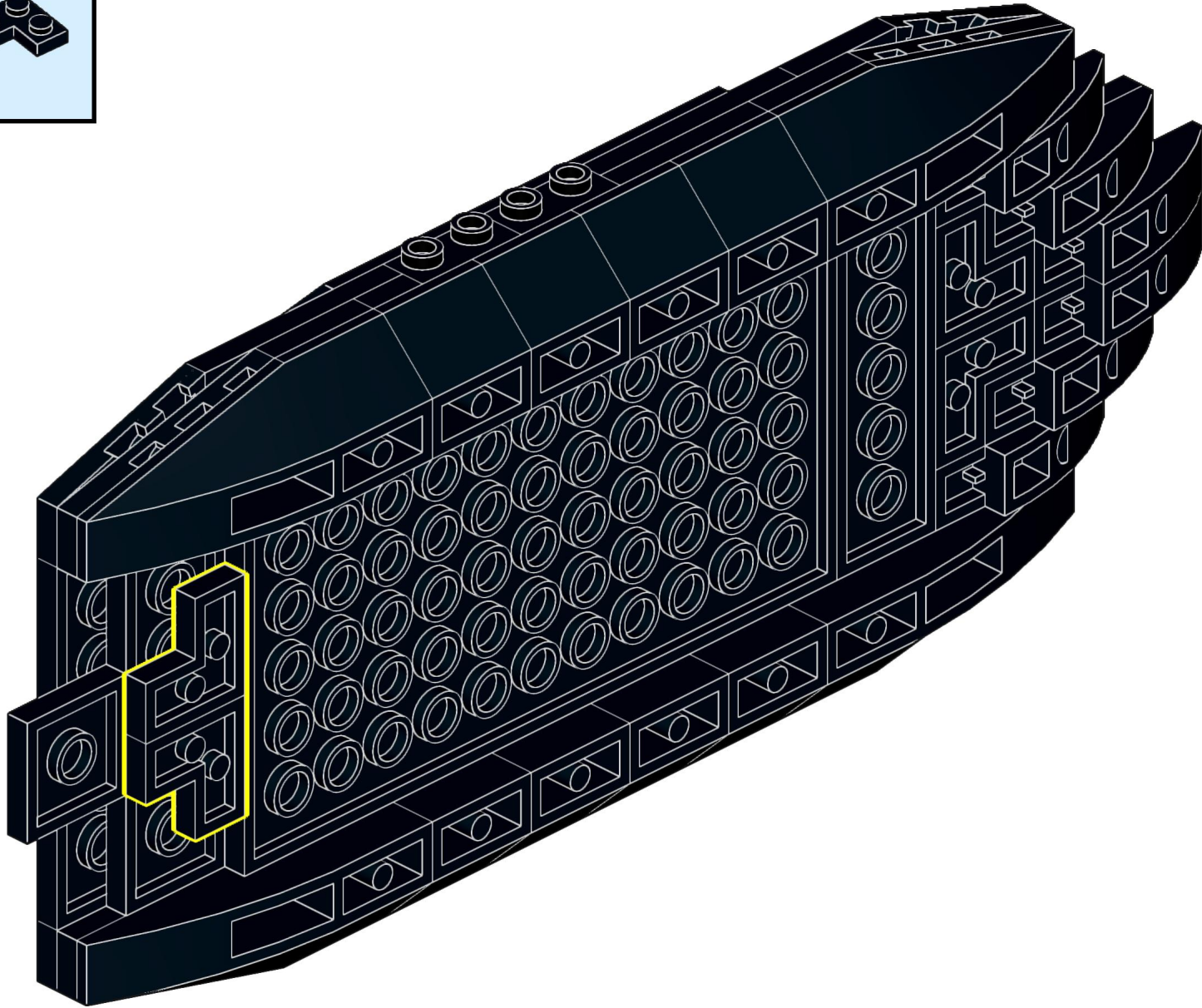
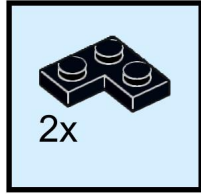

18

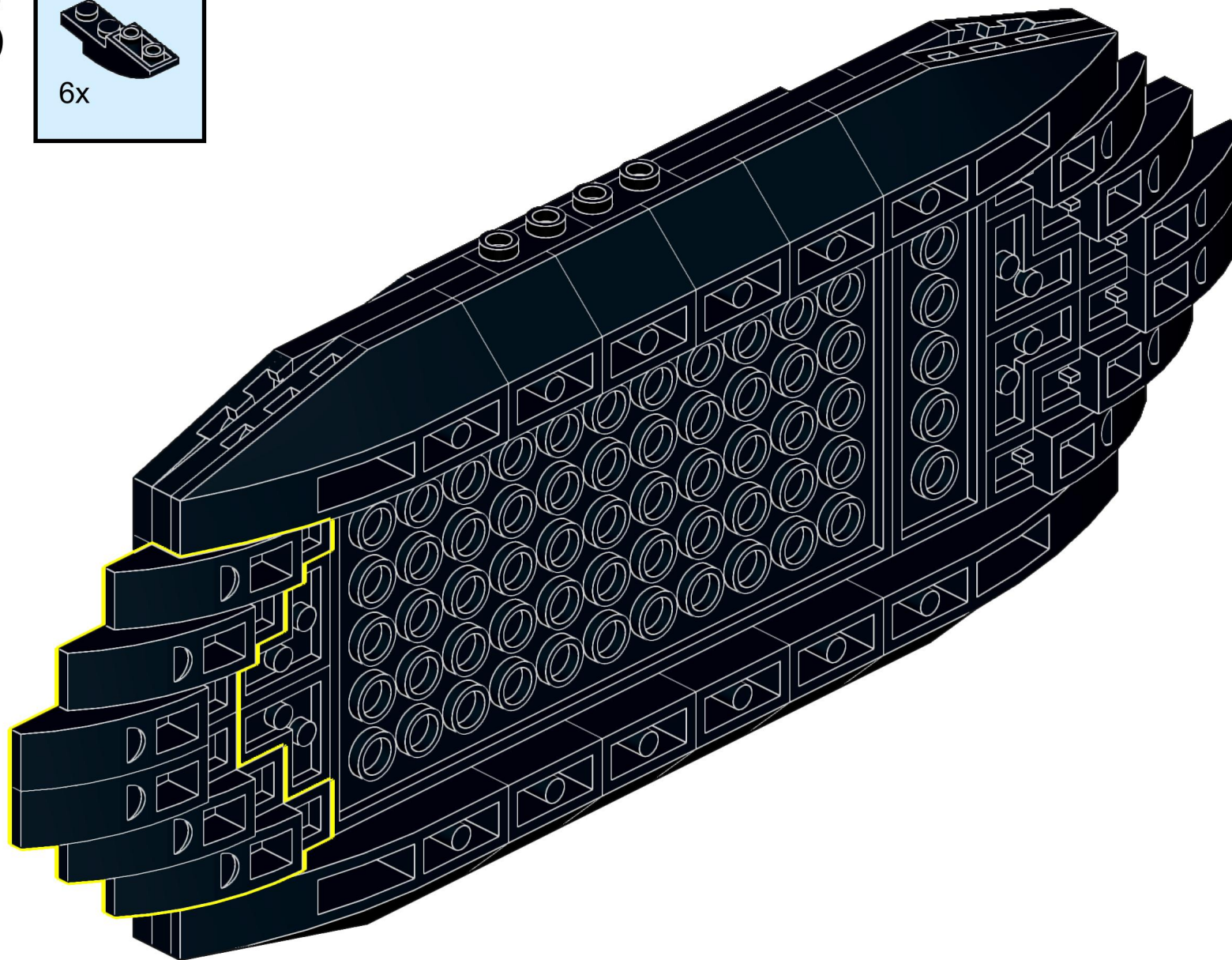
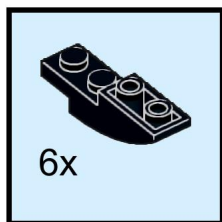

19

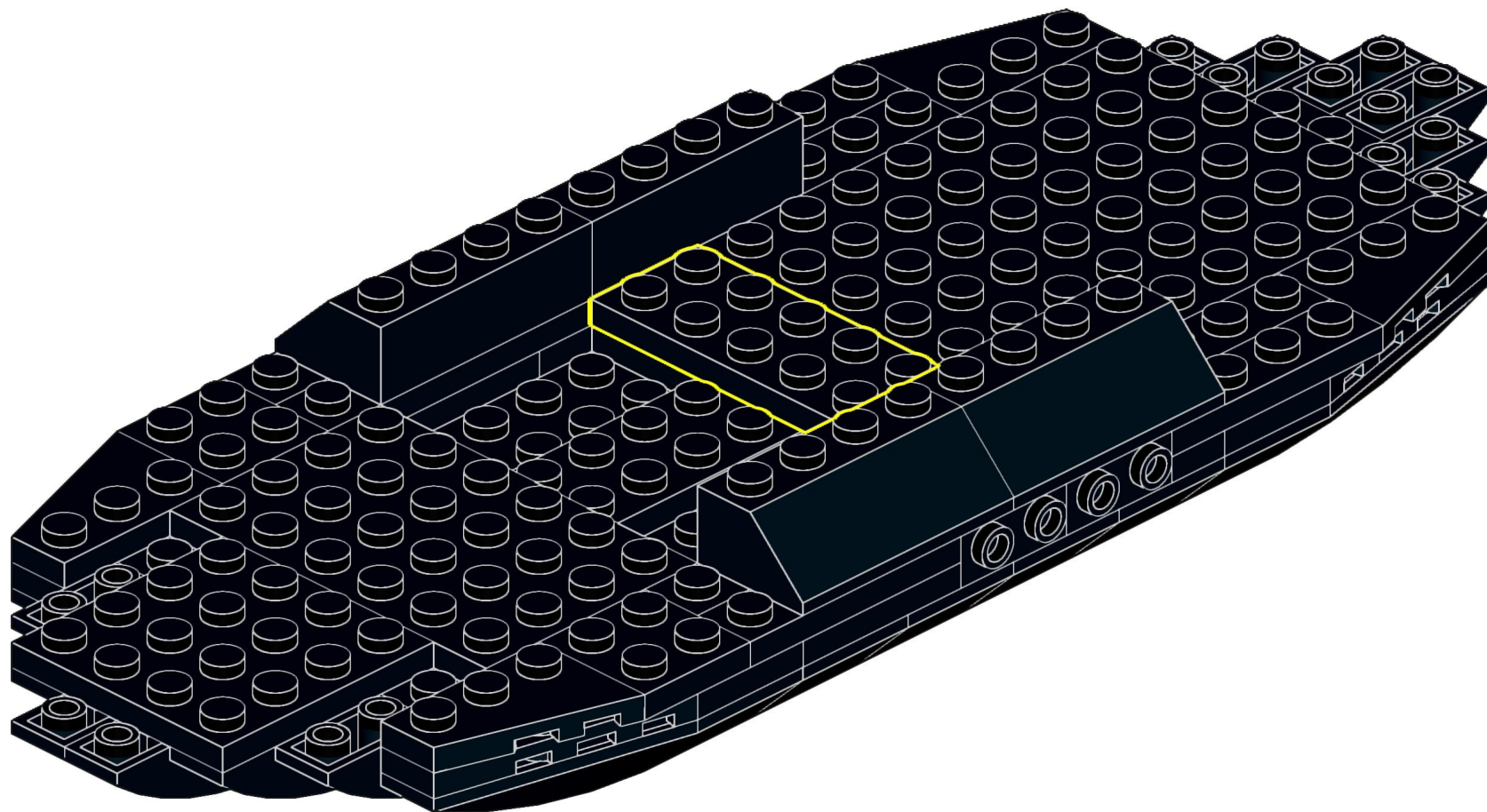
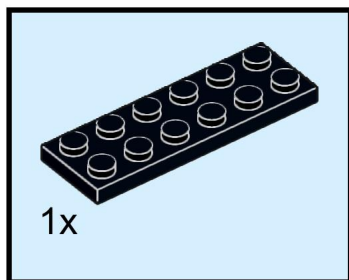

20

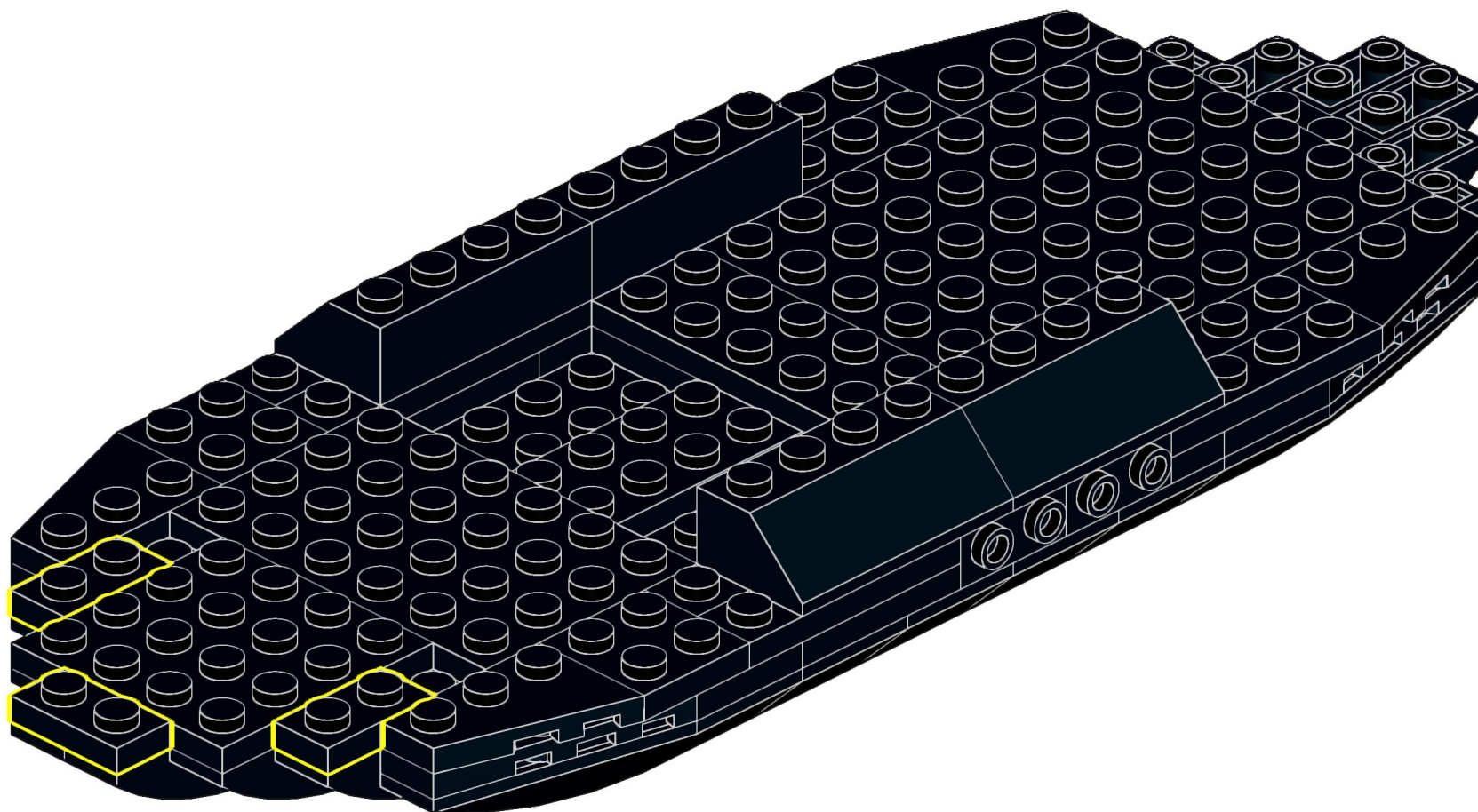
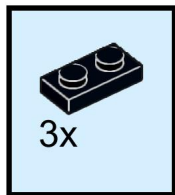

21

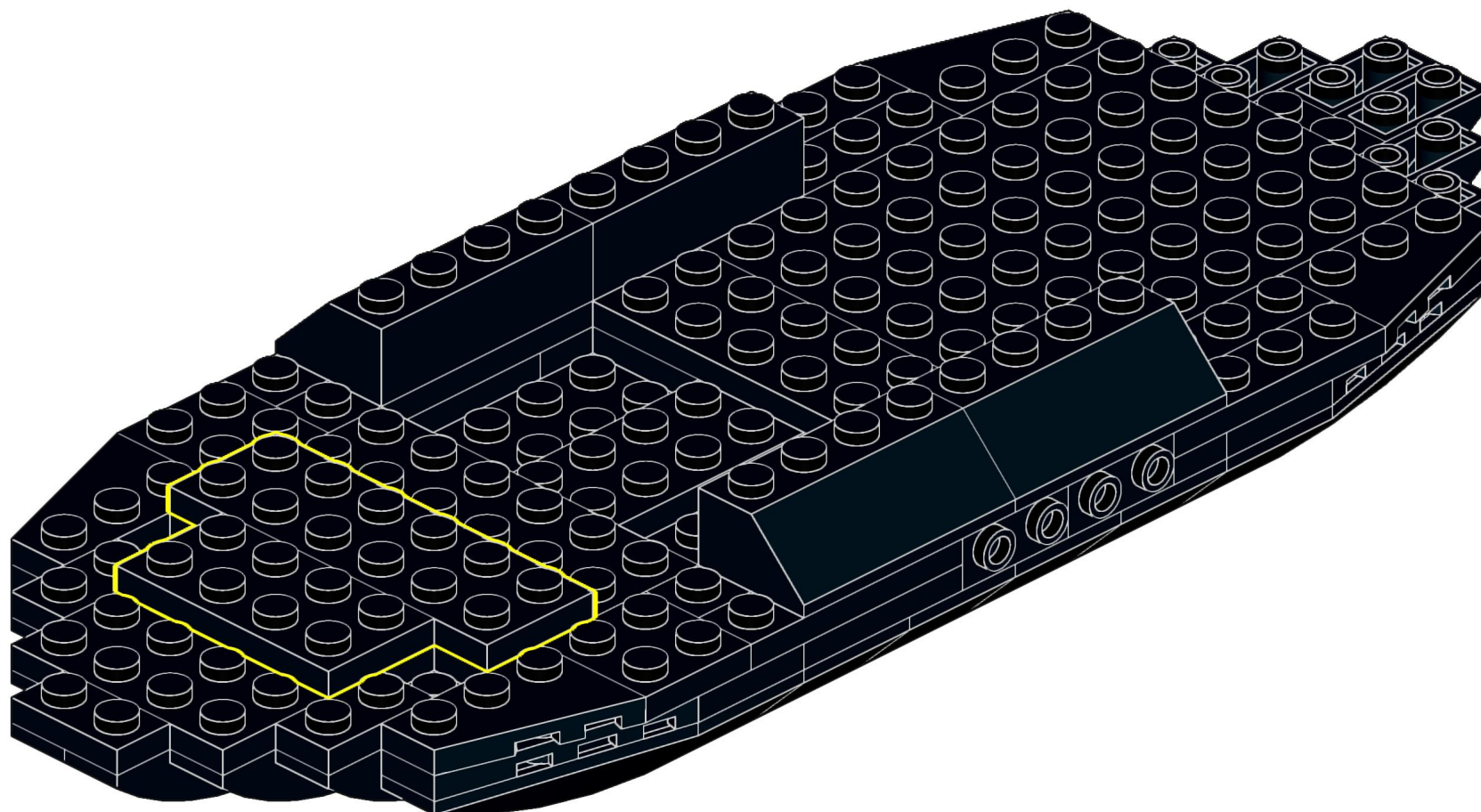
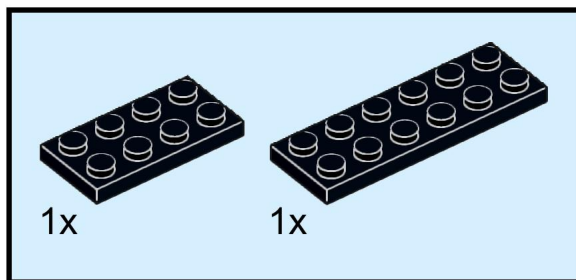

22

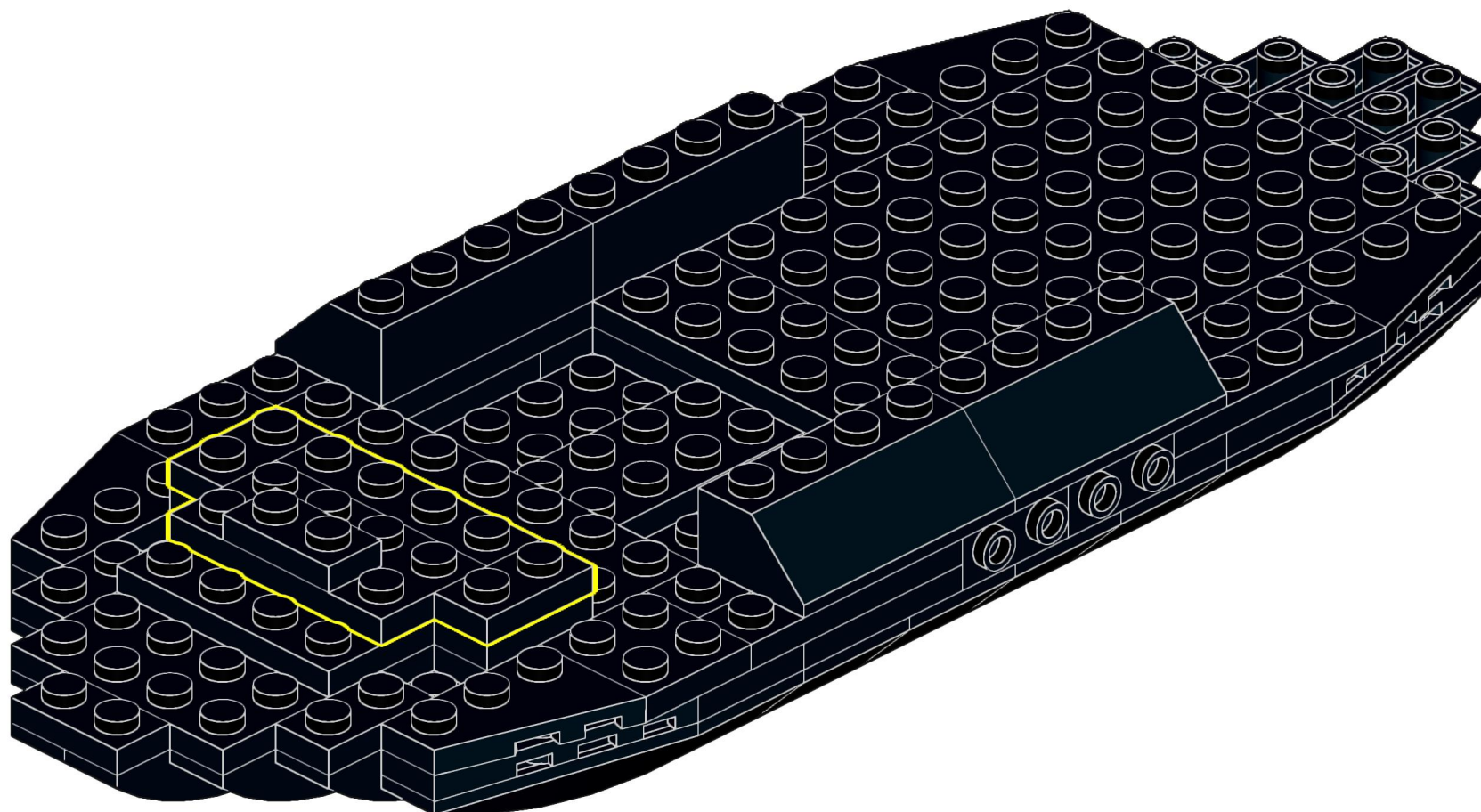
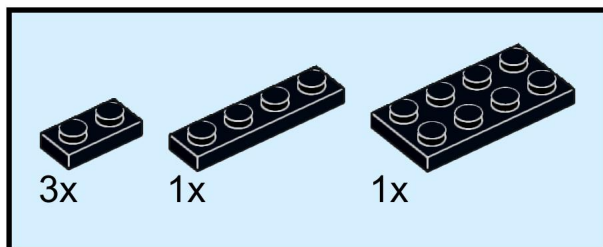

23

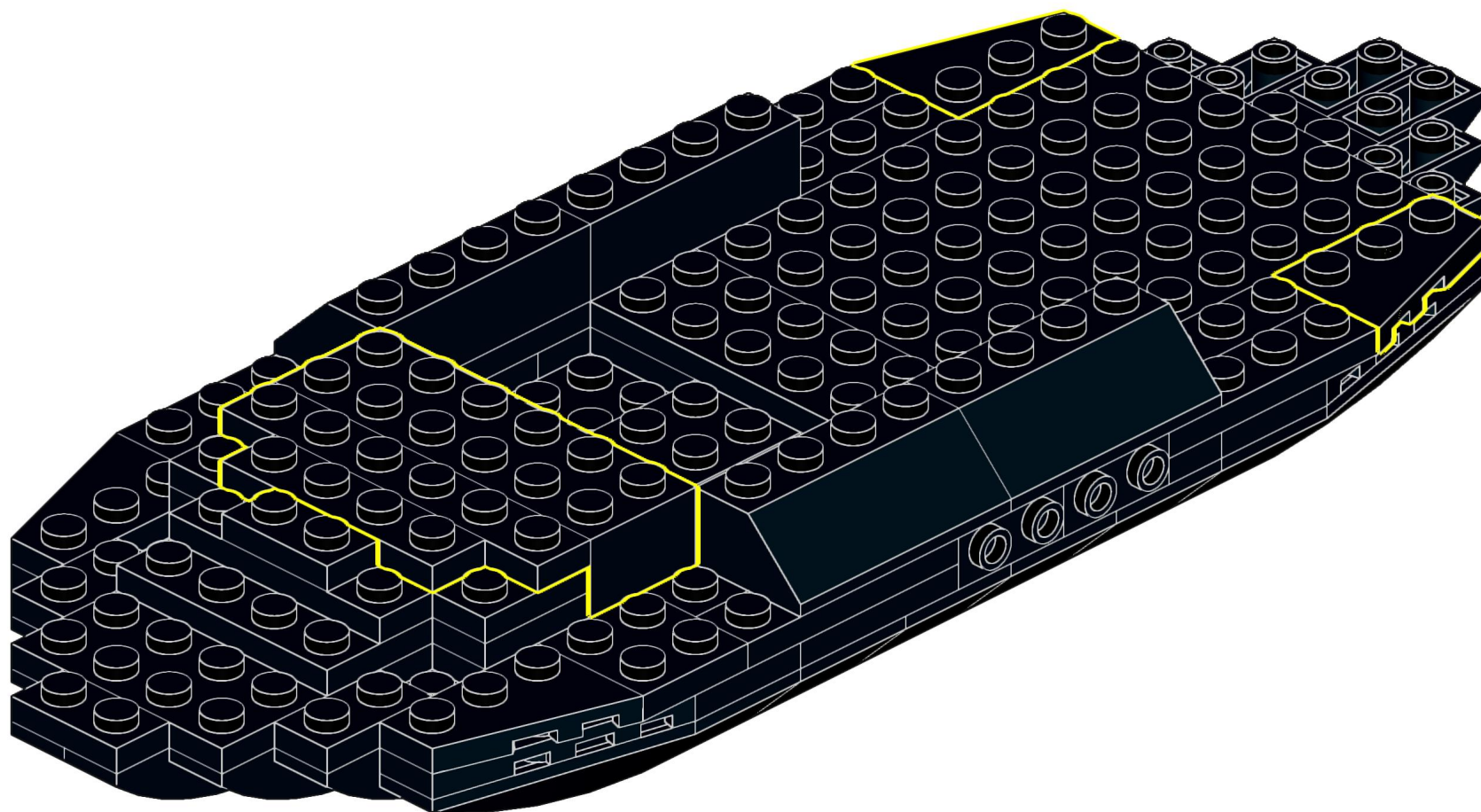
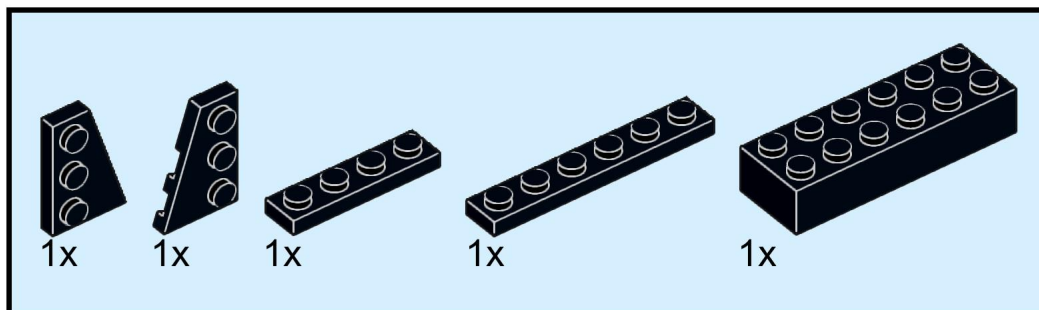

24

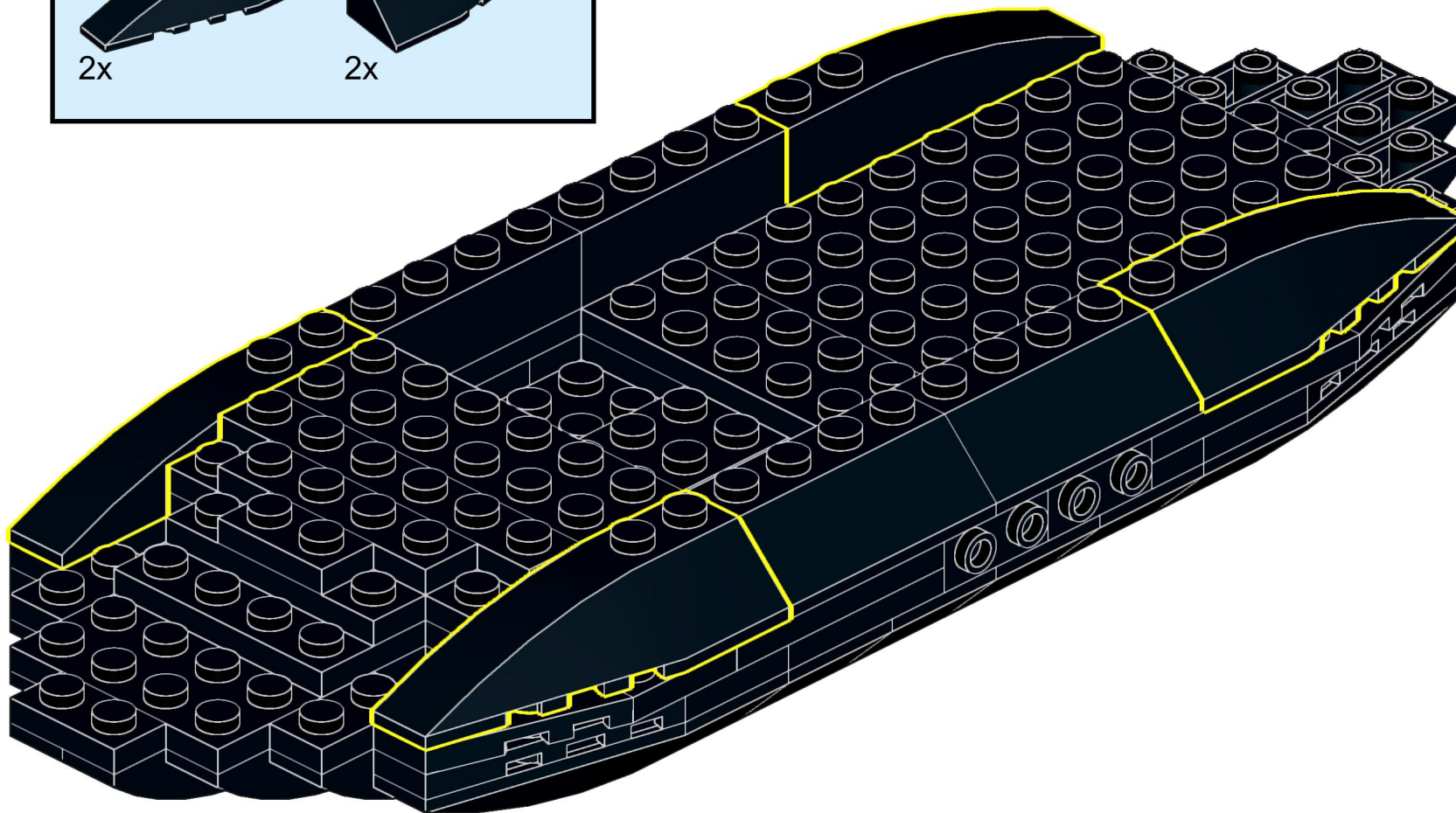
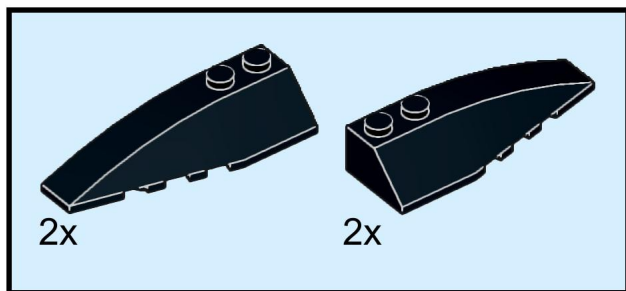

25

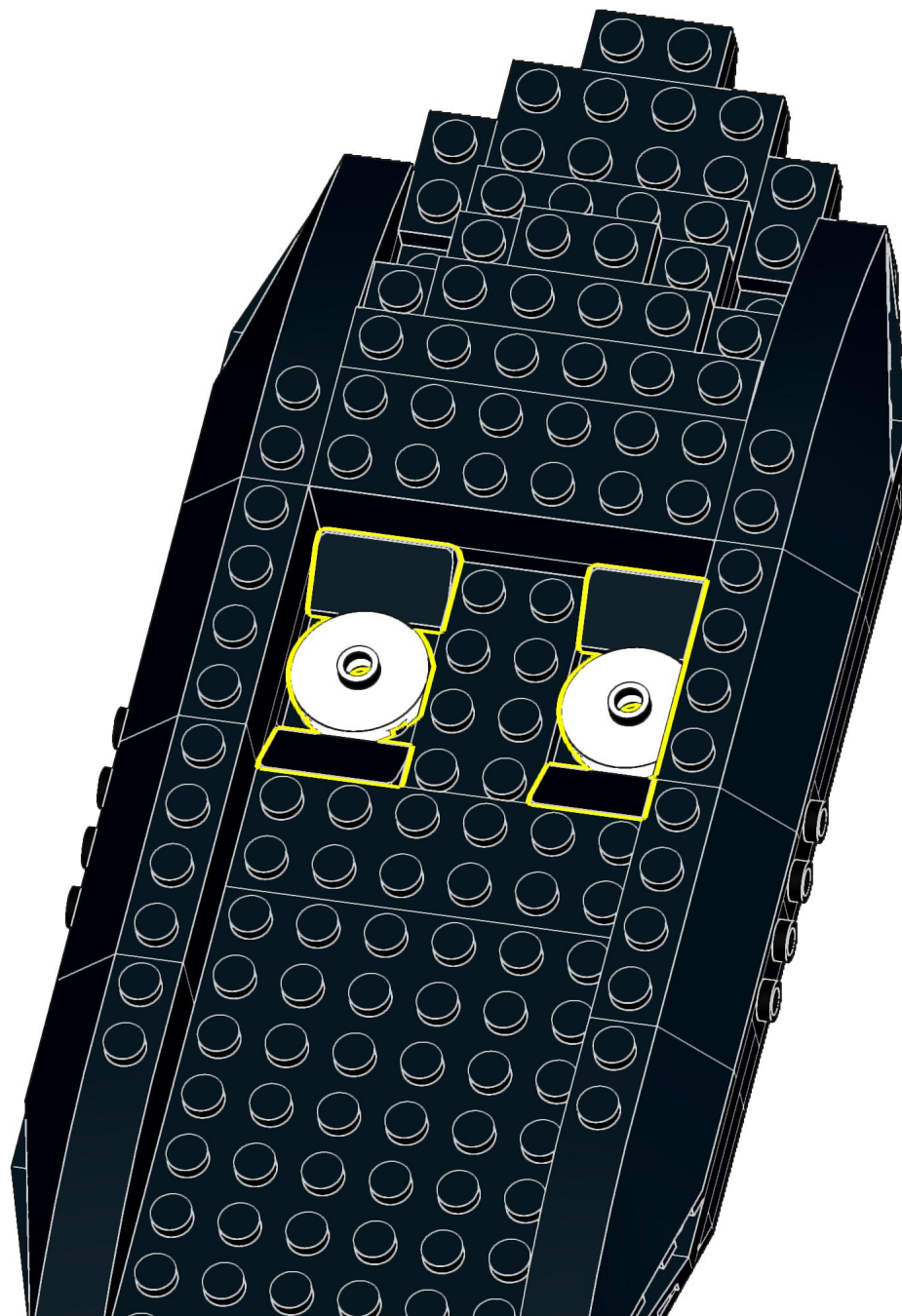
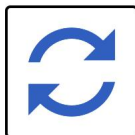
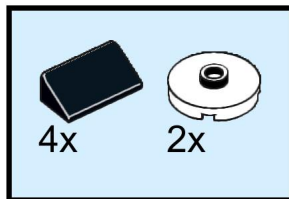

26

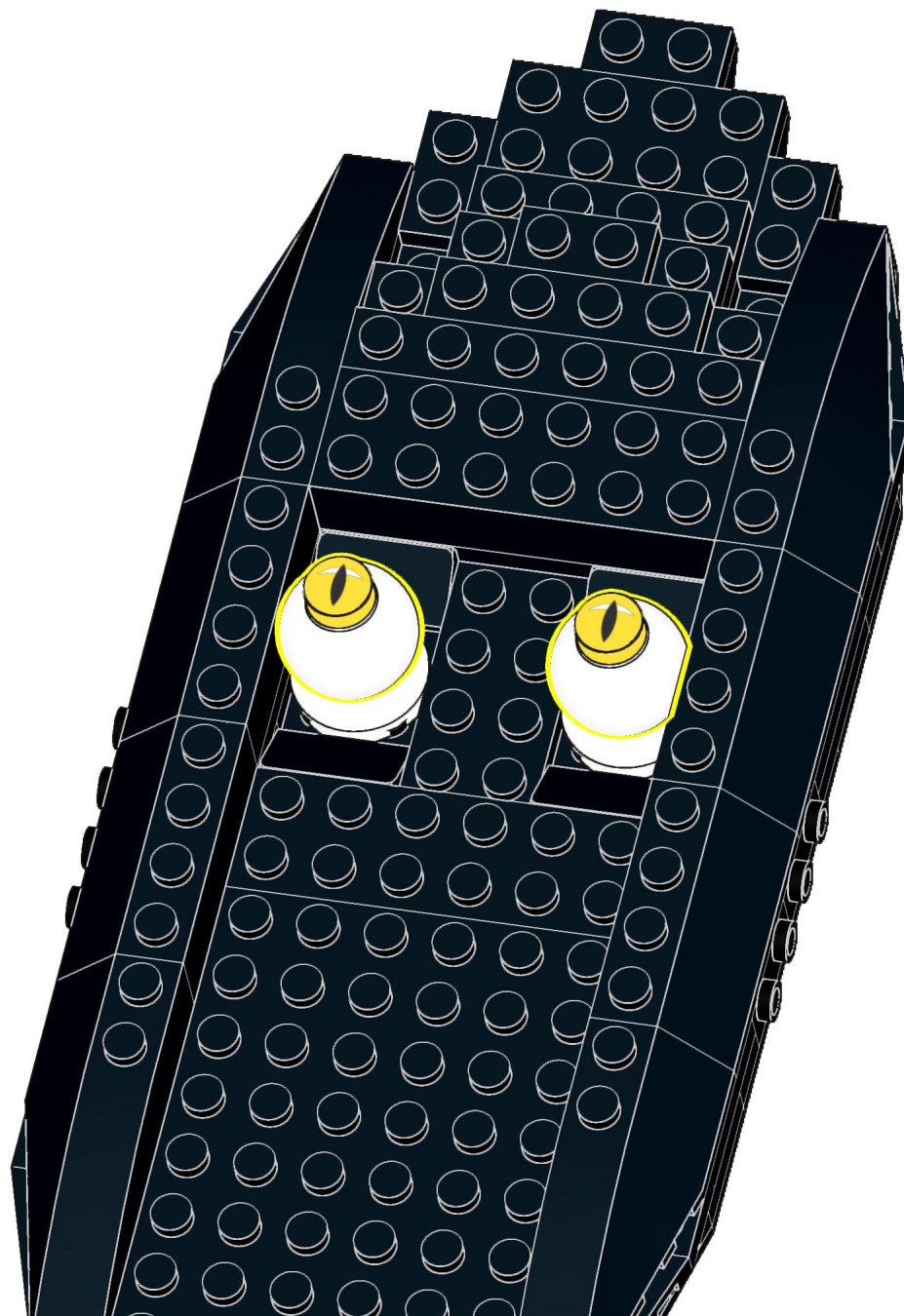
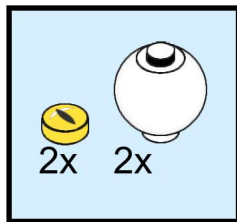

27

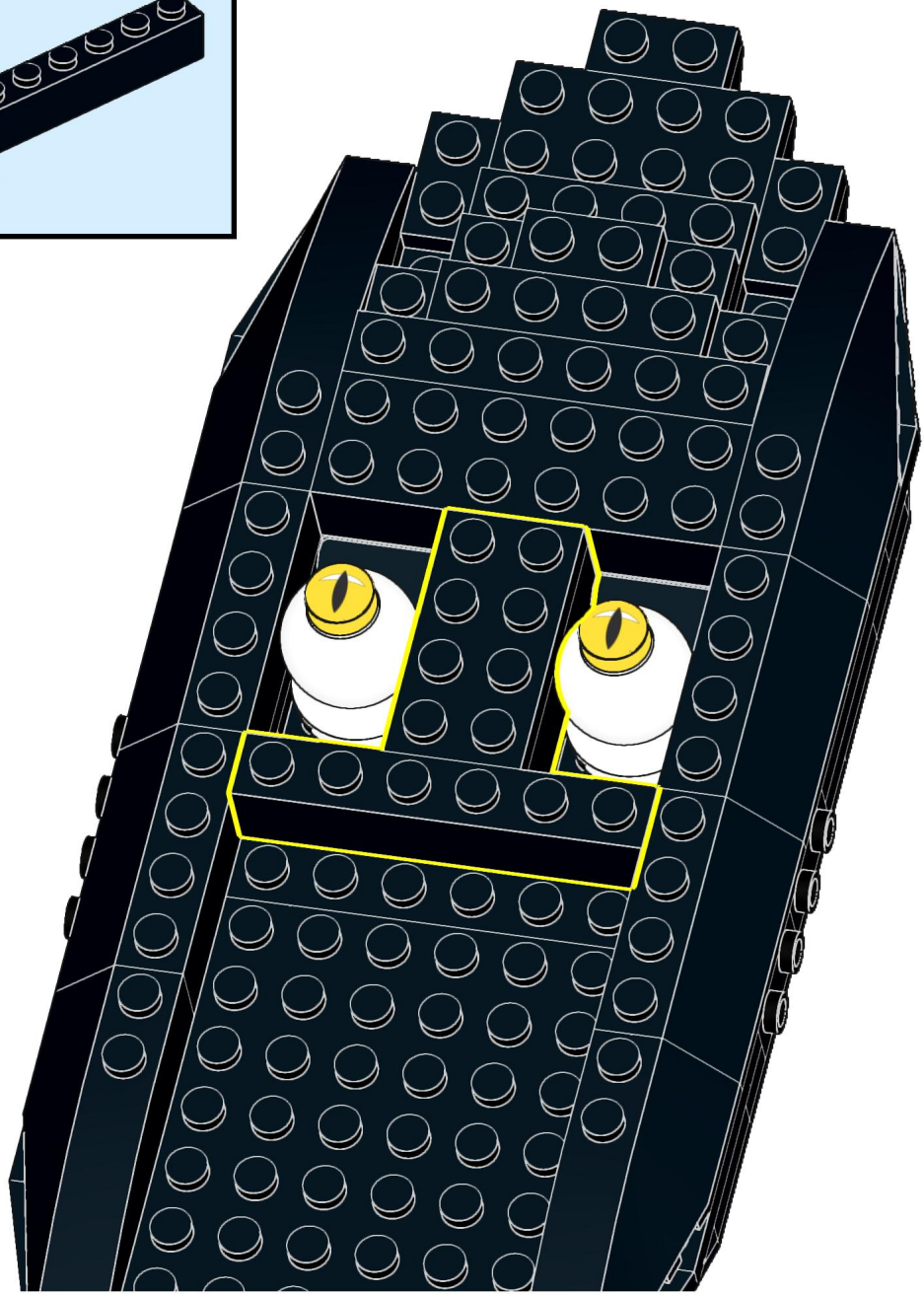
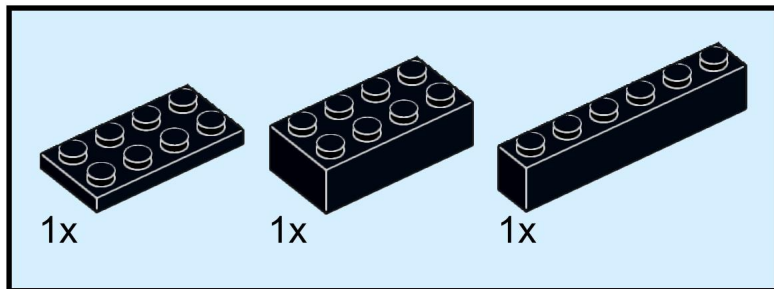

28

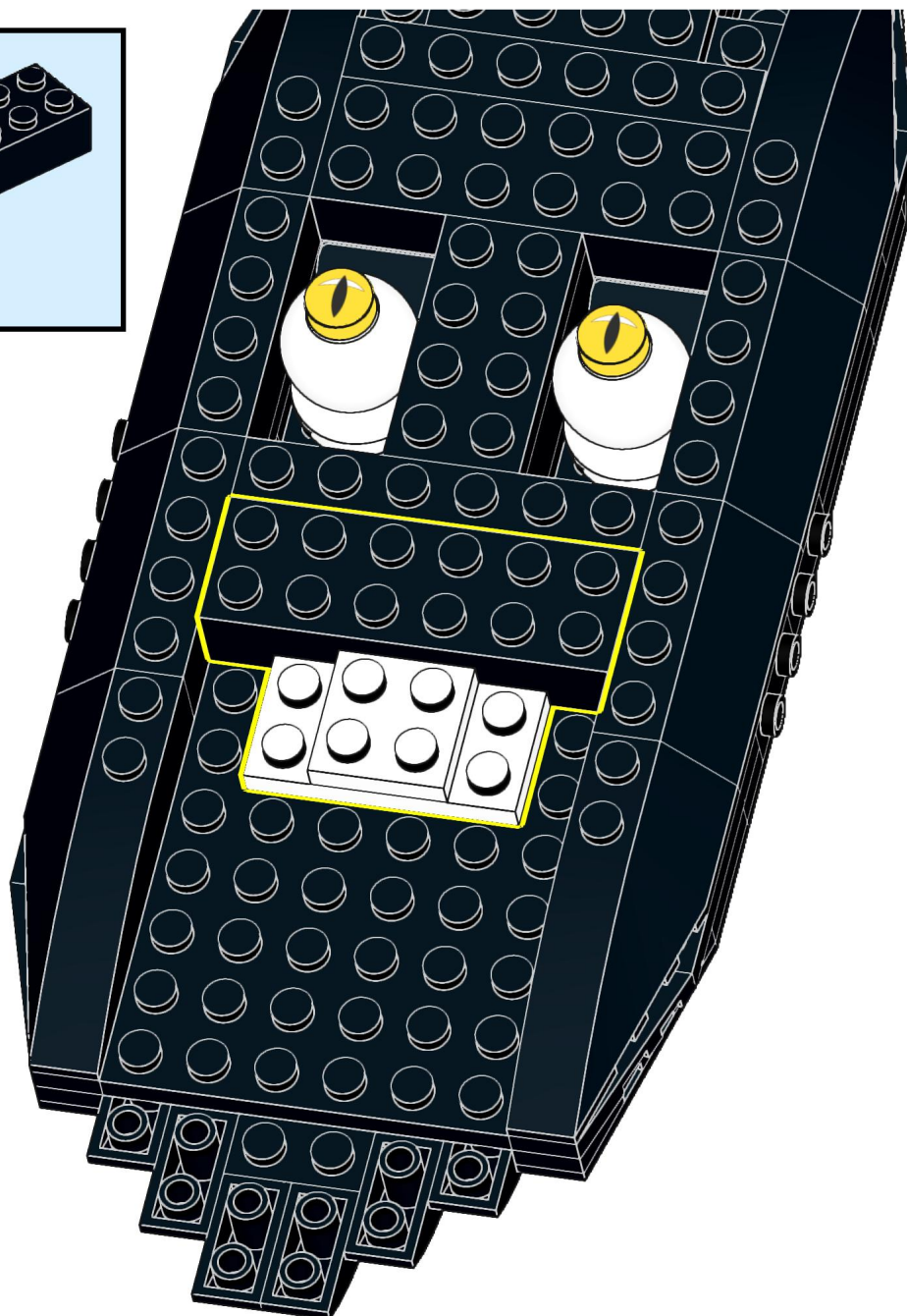
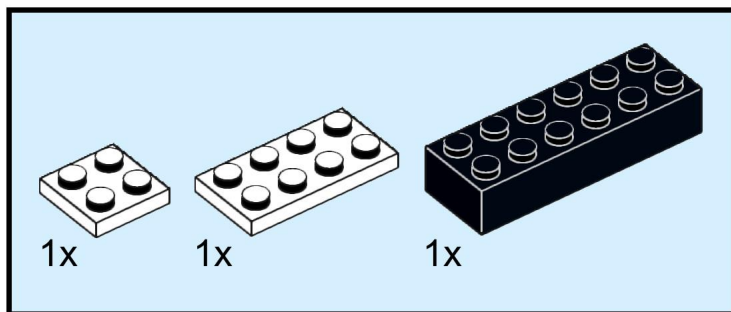

29

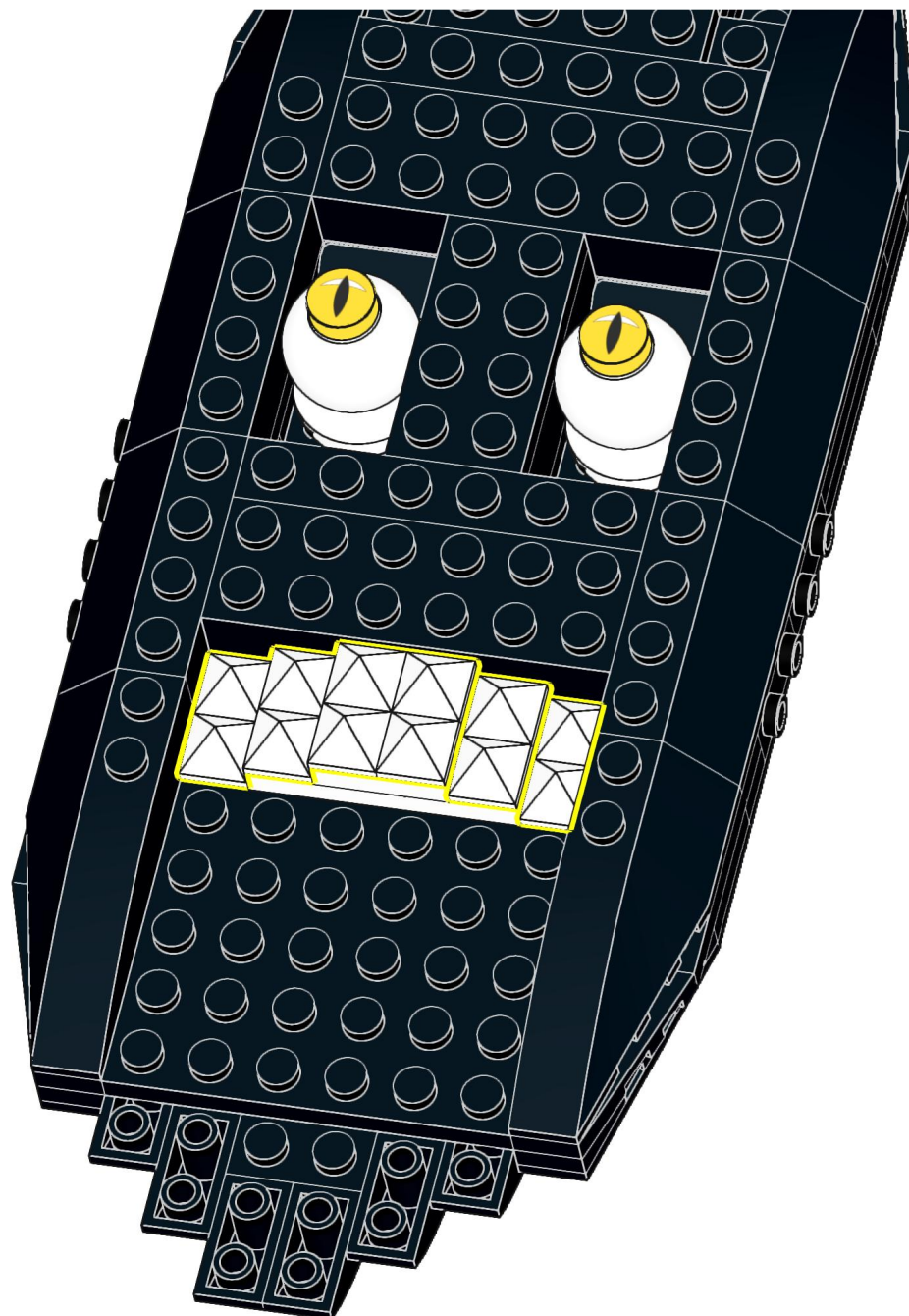
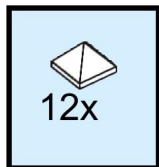

30

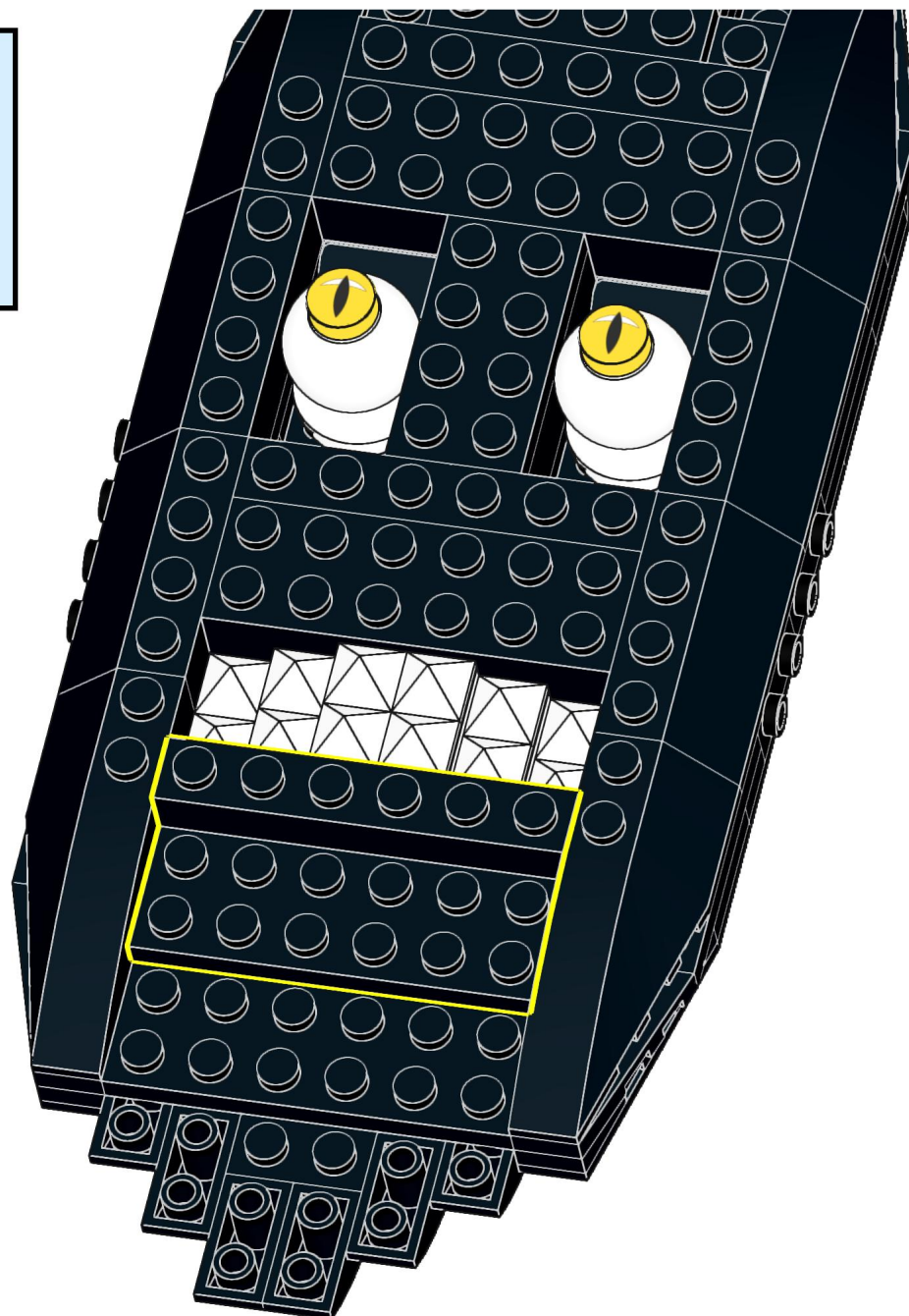
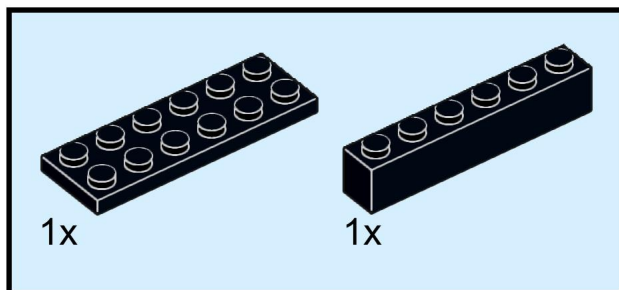

31

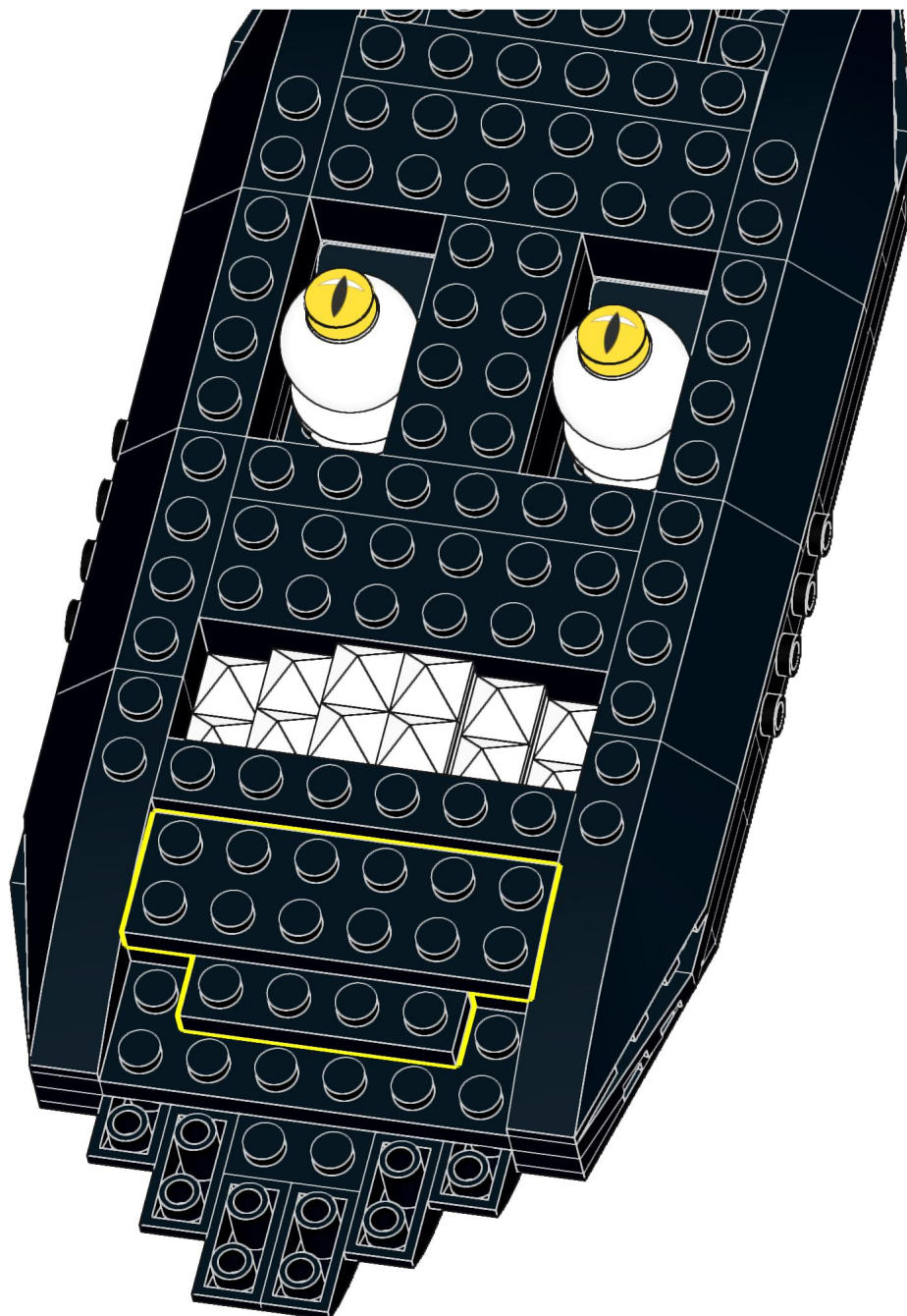
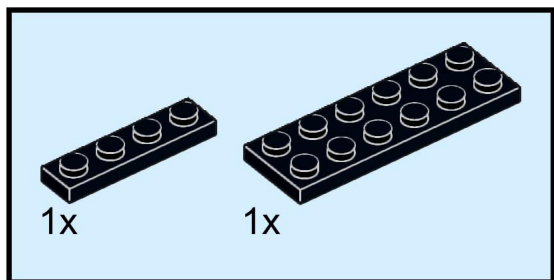

32

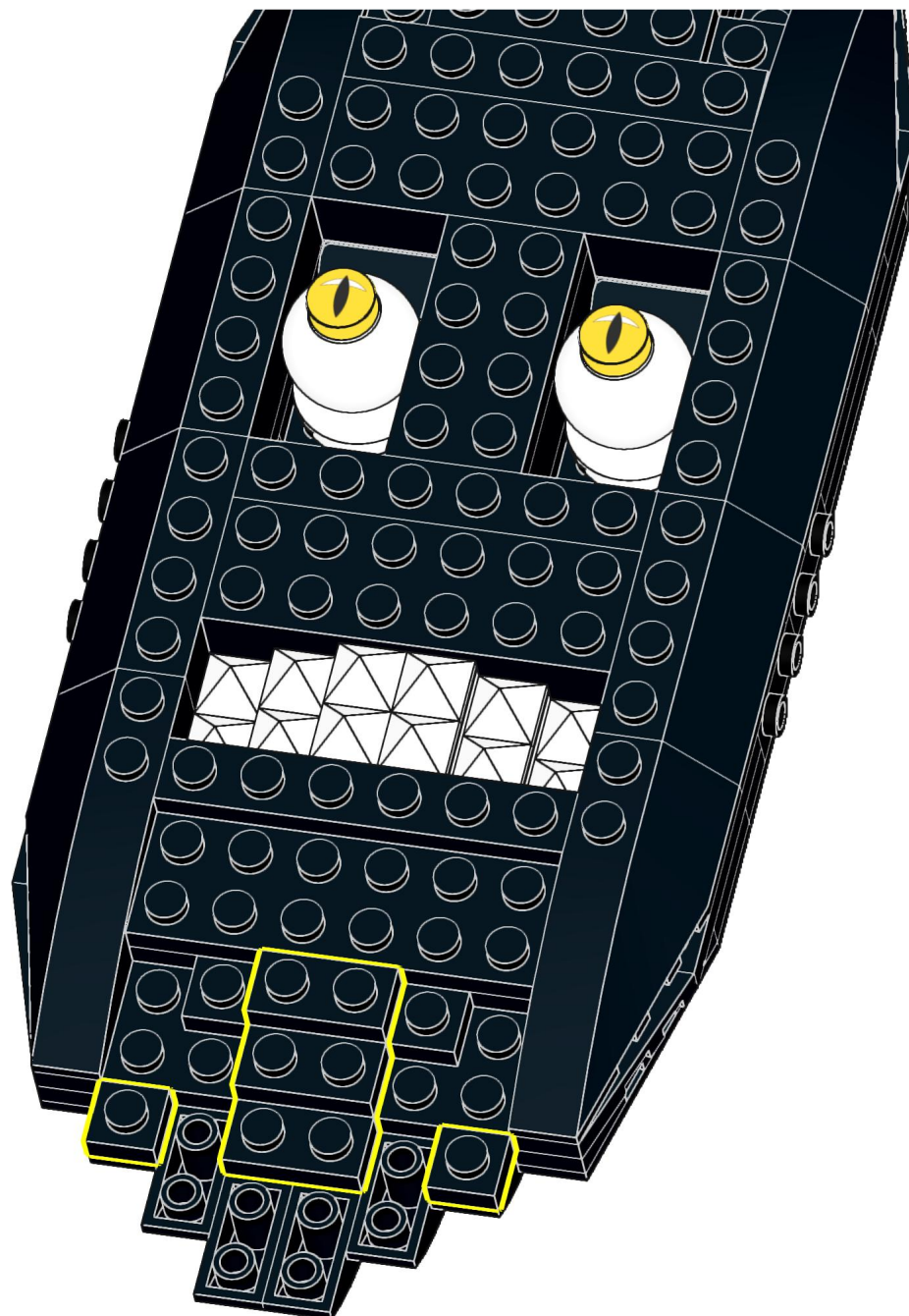
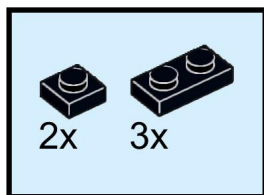

33

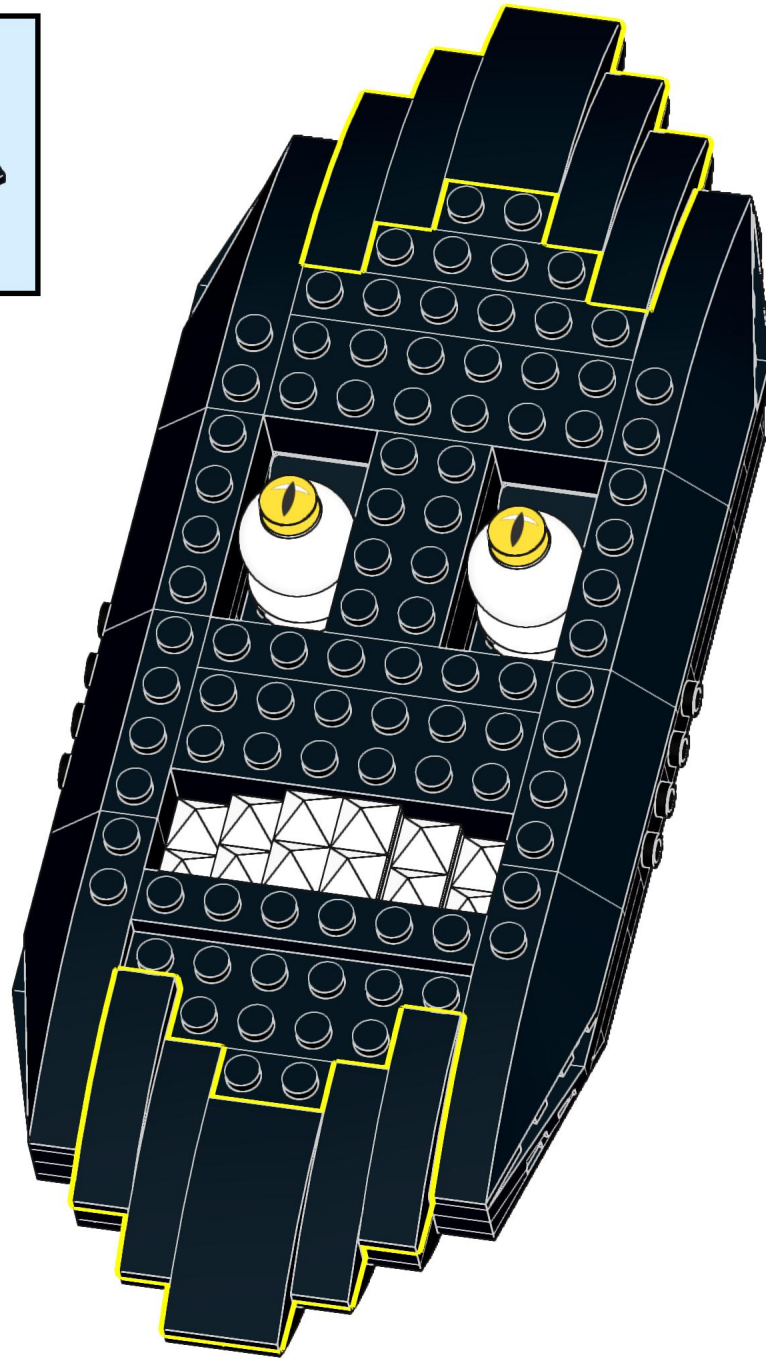
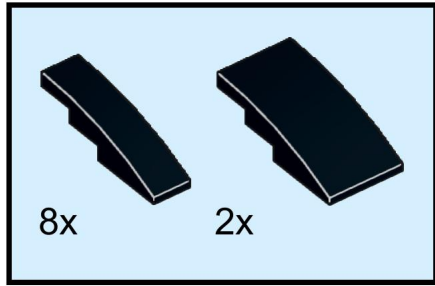

34

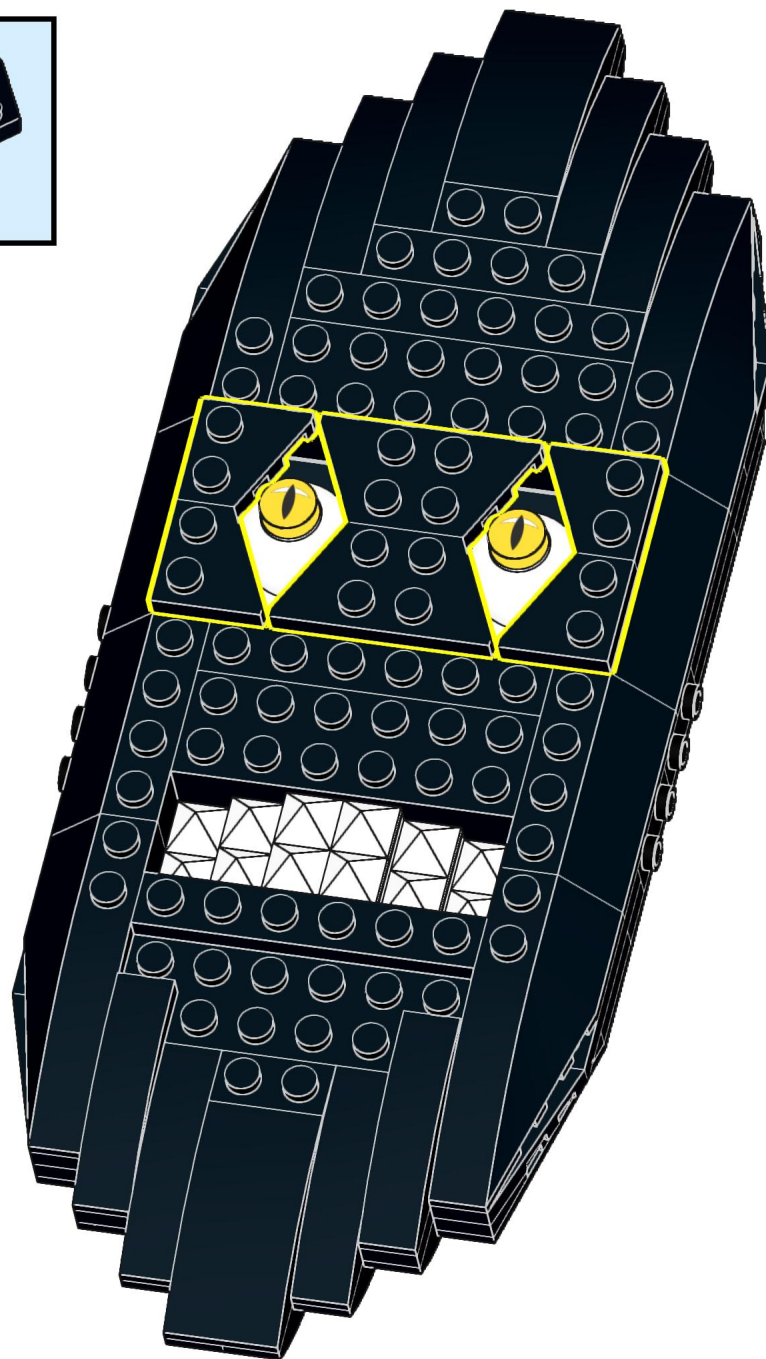
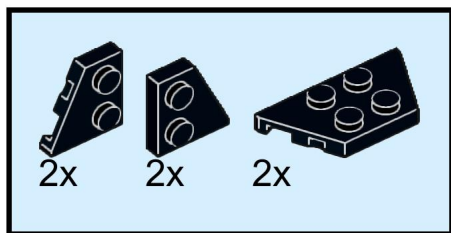

35

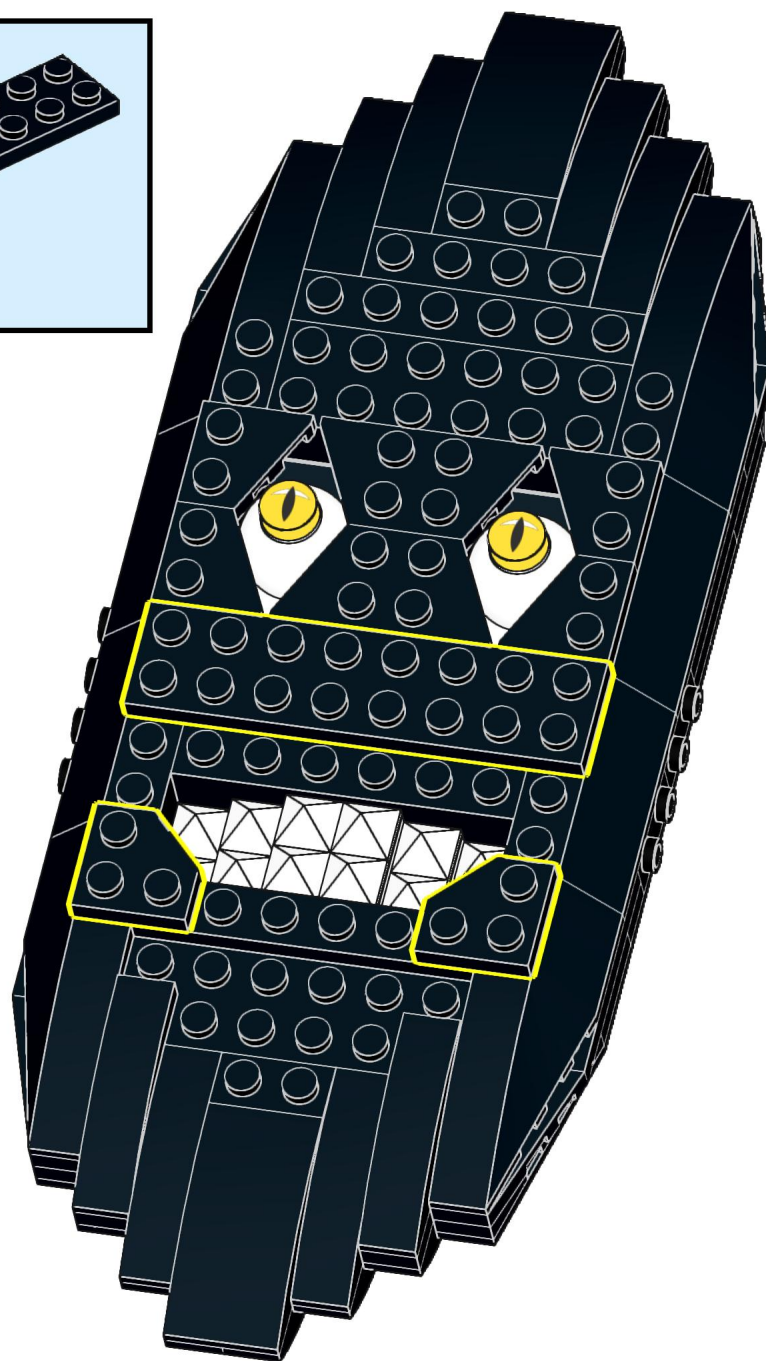
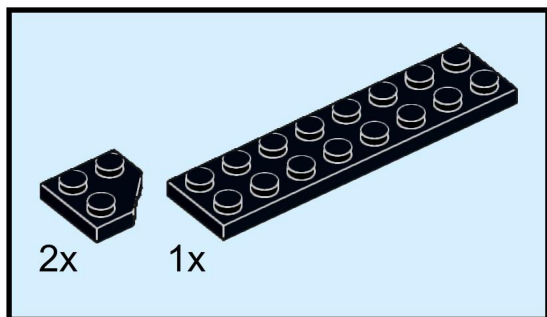

36

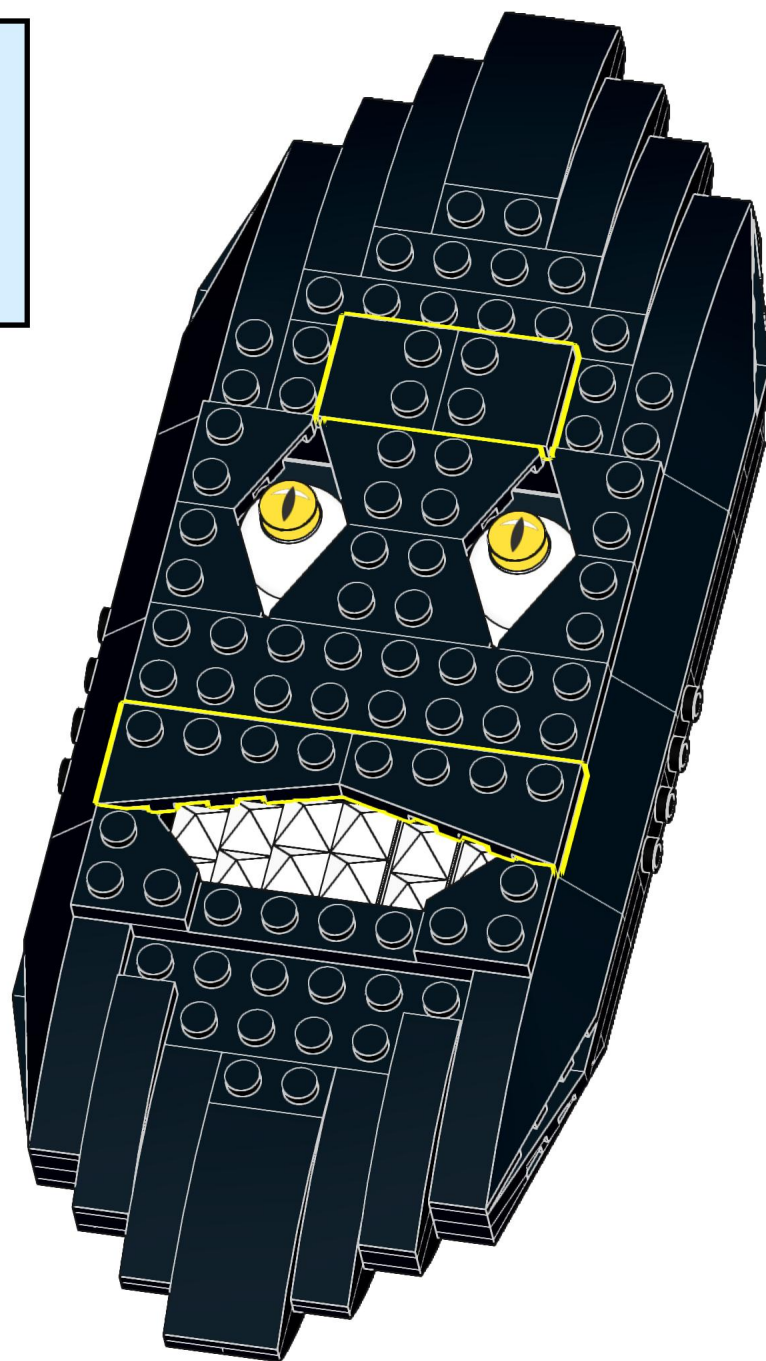
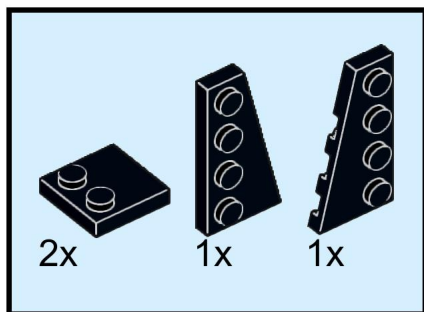

37

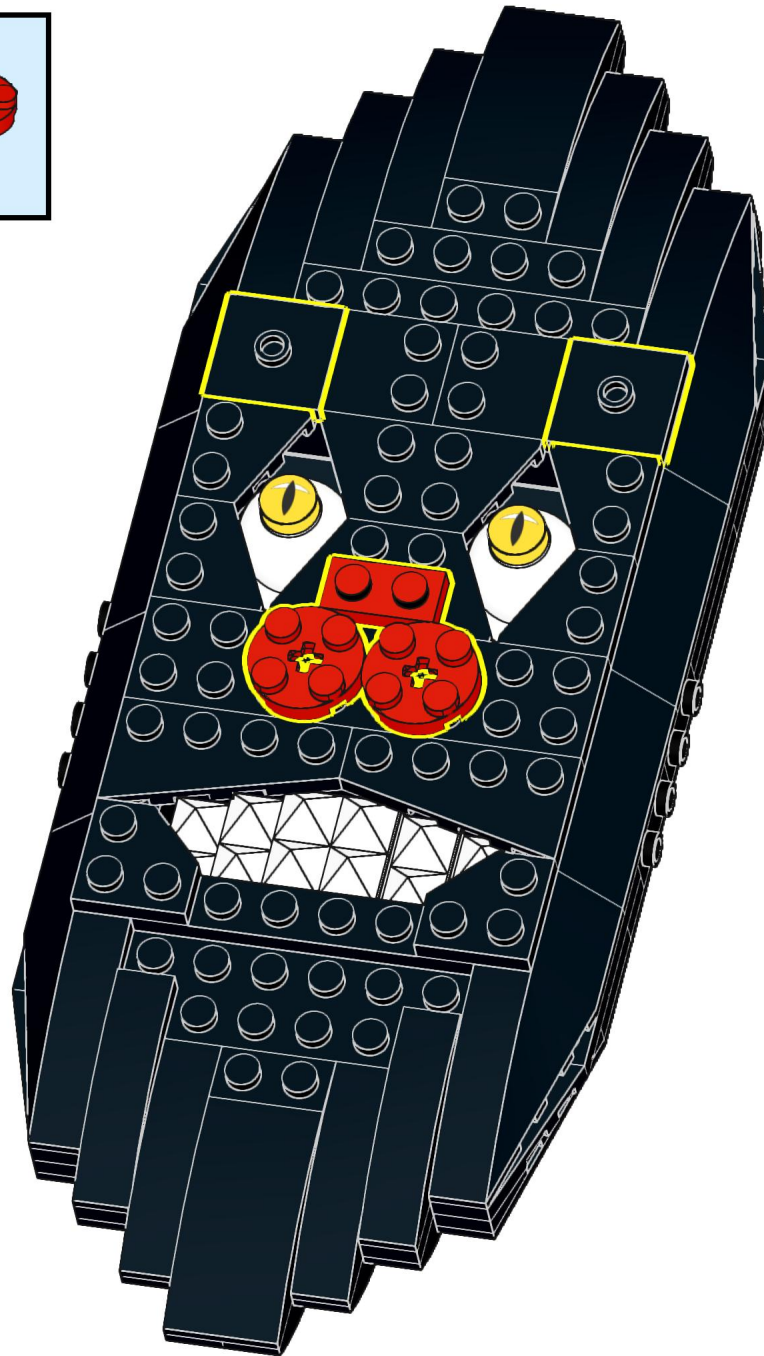
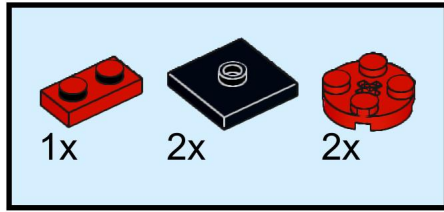

38

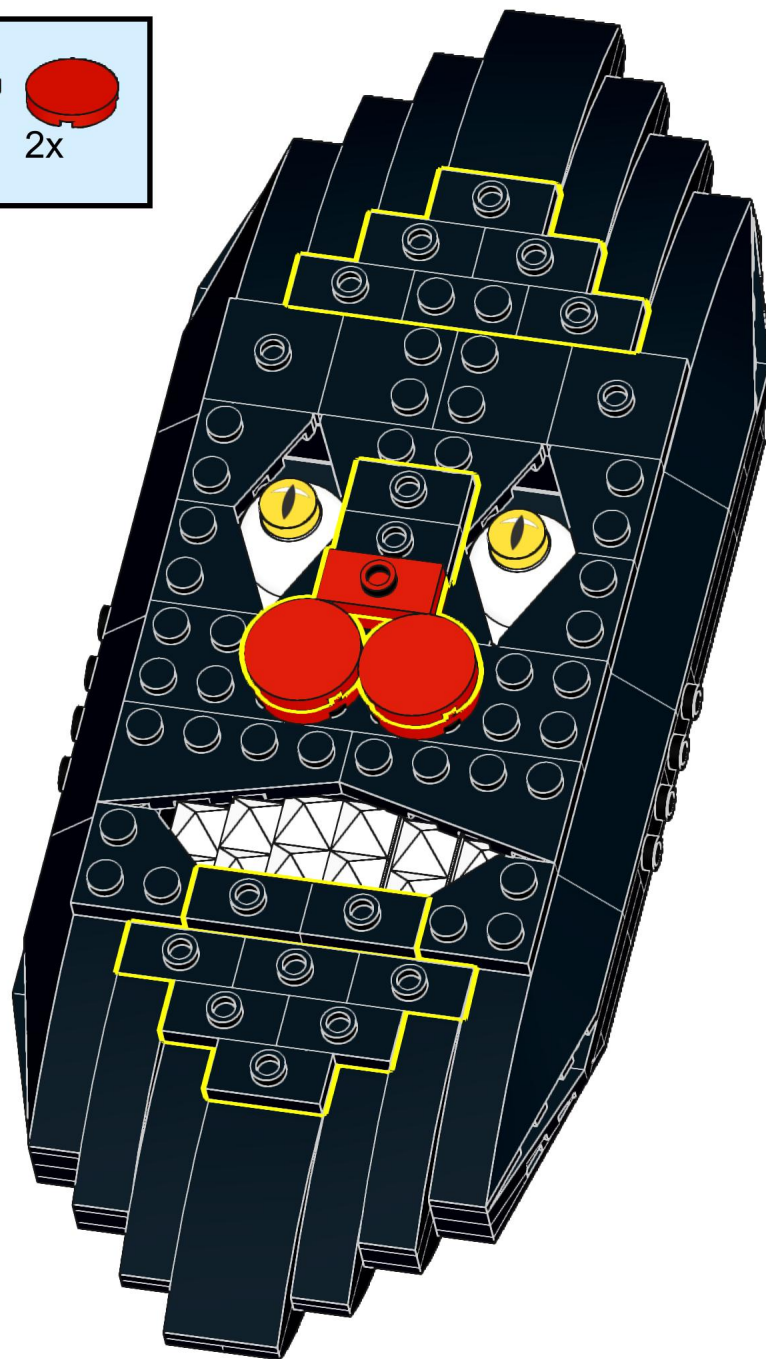
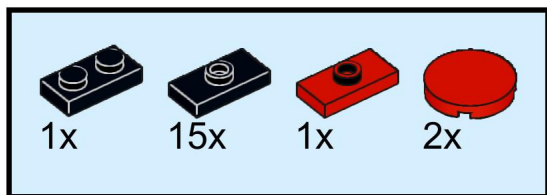

39

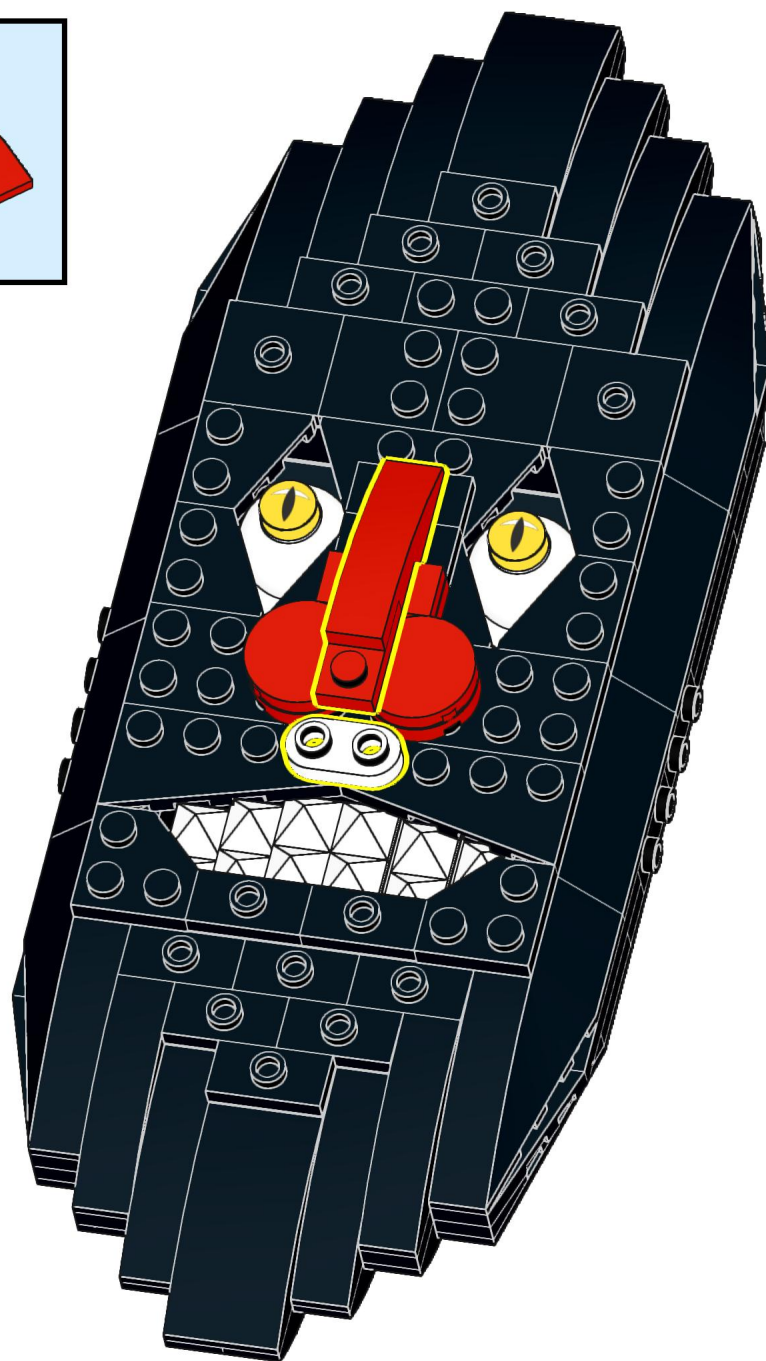
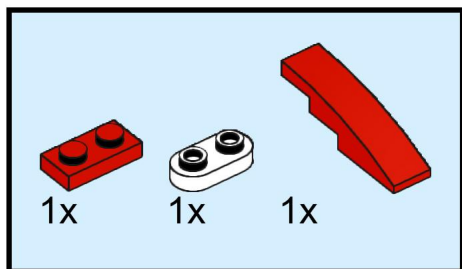

40

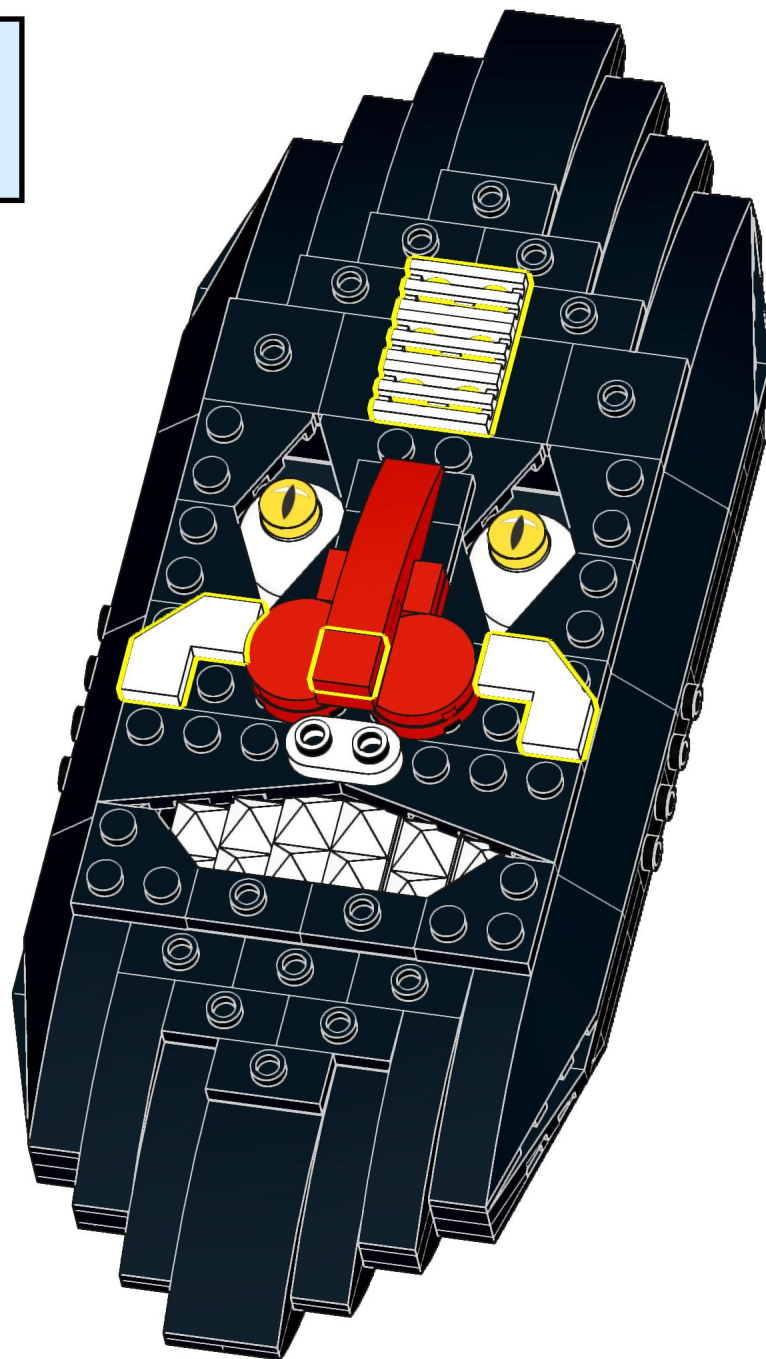
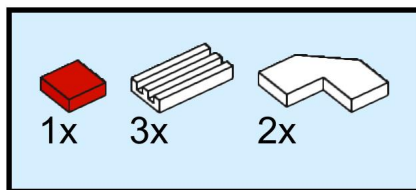

41

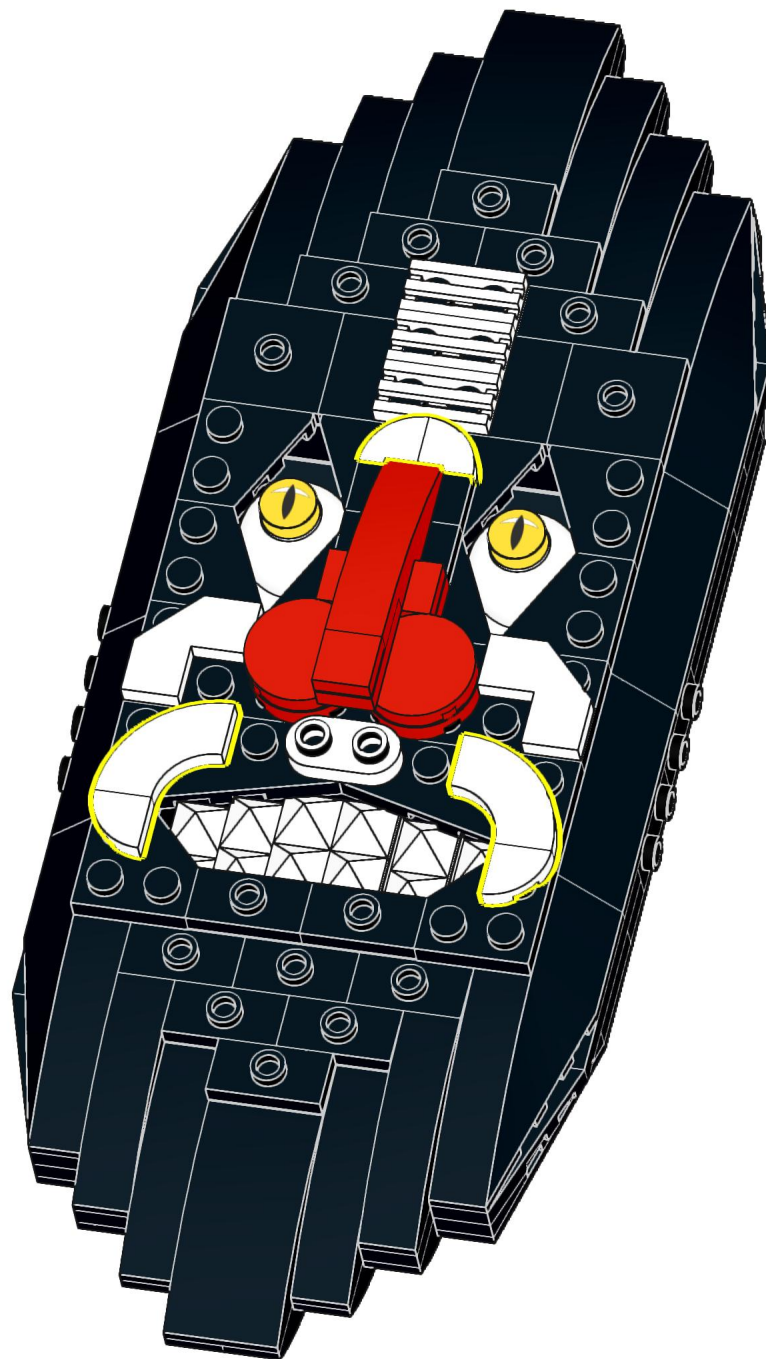
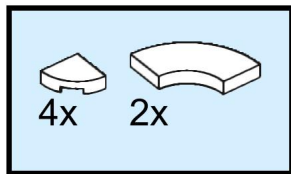

42

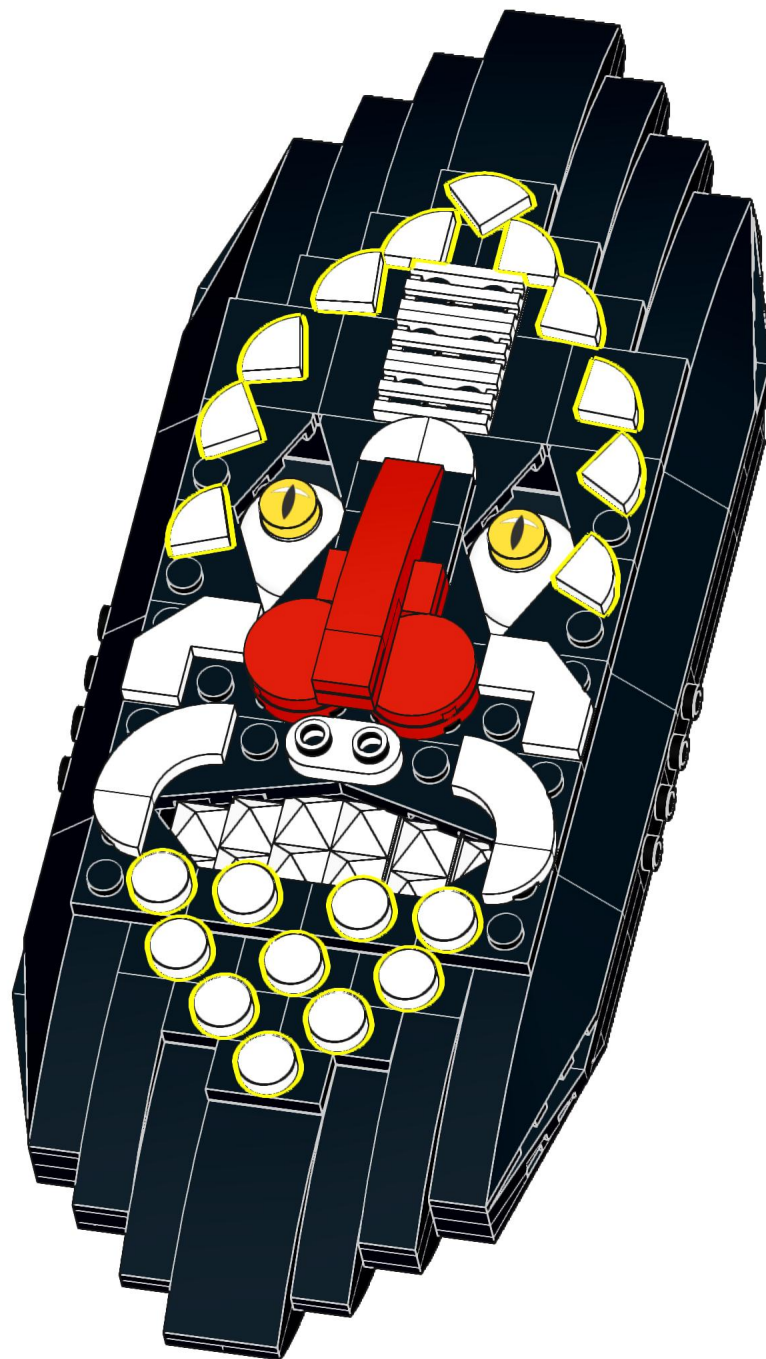
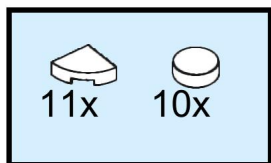

43

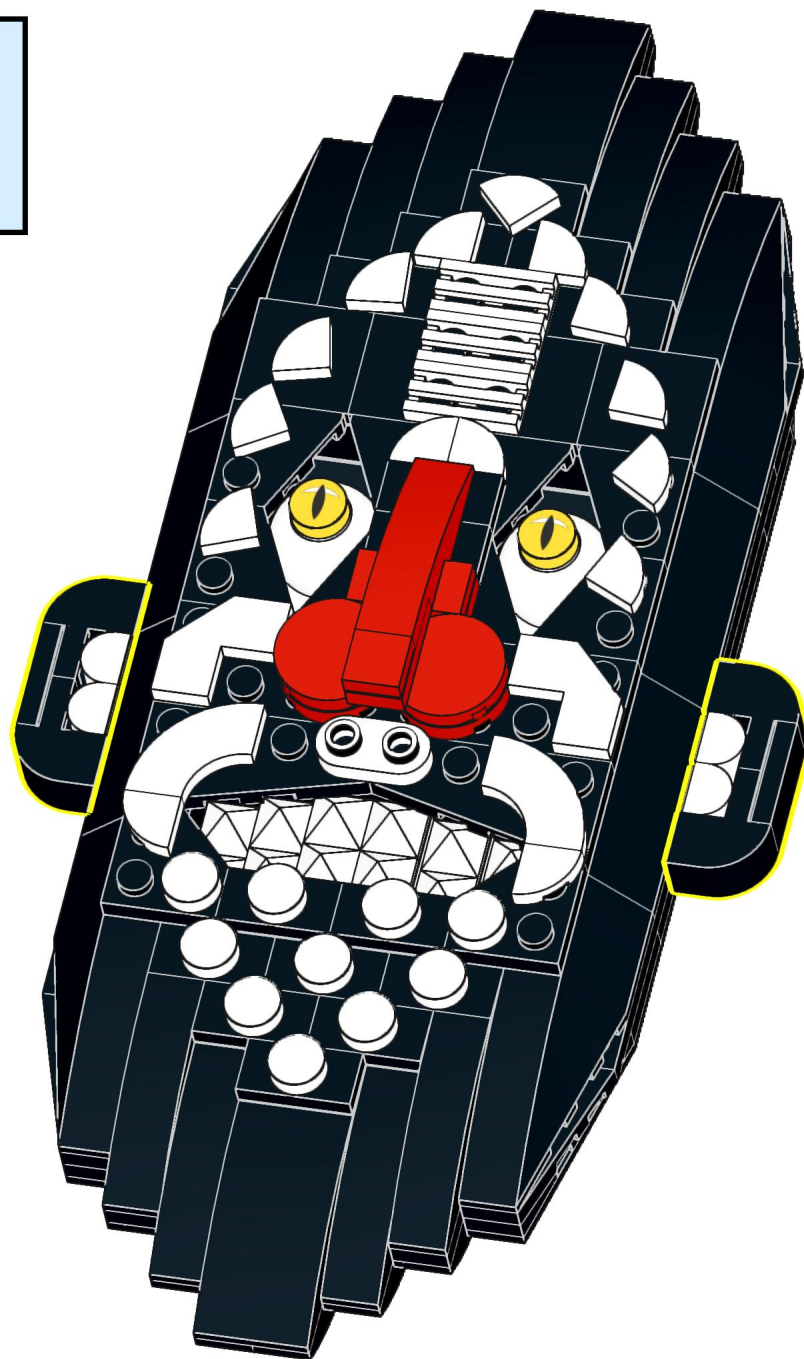
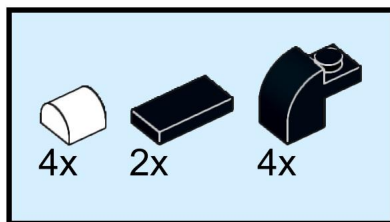

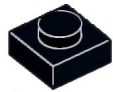

2x
3024
Black



4x
6091
Black

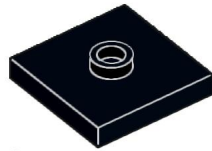

2x
87580
Black

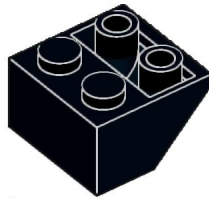

8x
3660
Black

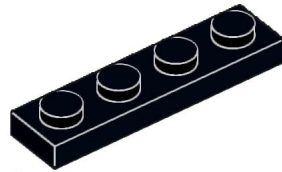

8x
3710
Black

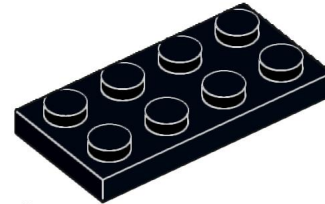

4x
3020
Black



2x
93606
Black



2x
3069
Black



2x
24307
Black

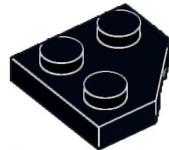

2x
26601
Black

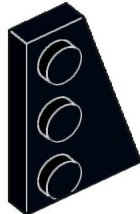

3x
43722
Black



8x
61678
Black

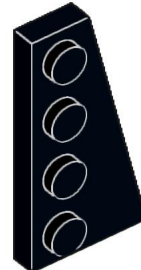

3x
41769
Black

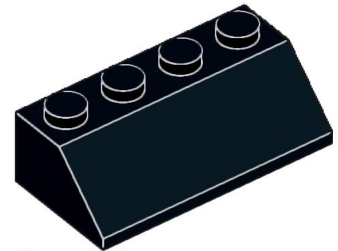

4x
3037
Black

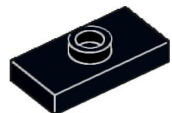

15x
3794b
Black



2x
24299
Black

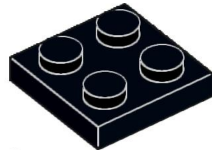

3x
3022
Black



3x
43723
Black

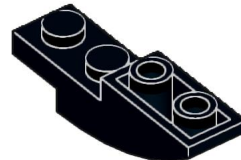

12x
13547
Black



3x
41770
Black

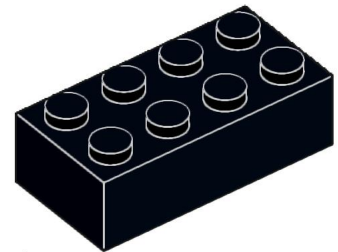

1x
3001
Black

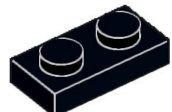

12x
3023
Black



4x
2420
Black

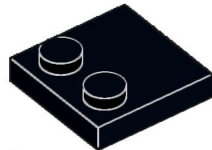

2x
33909
Black



2x
3021
Black

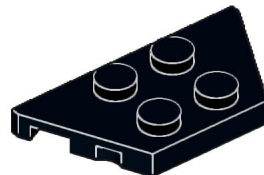

2x
51739
Black



4x
85984
Black



4x
99206
Black

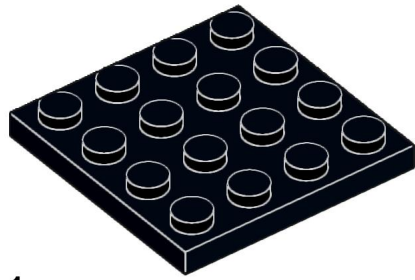

1x
3031
Black

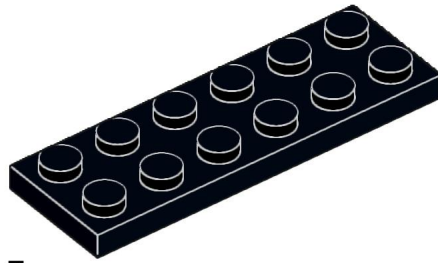

7x
3795
Black

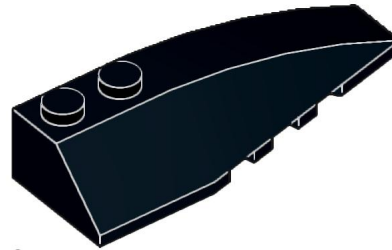

2x
41747
Black



2x
3032
Black



3x
3666
Black

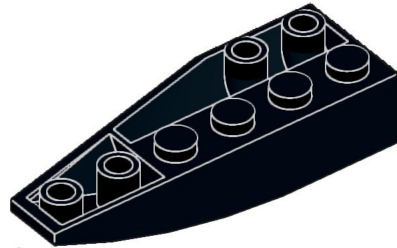

2x
41764
Black

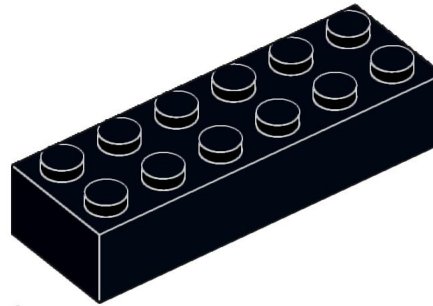

2x
2456
Black

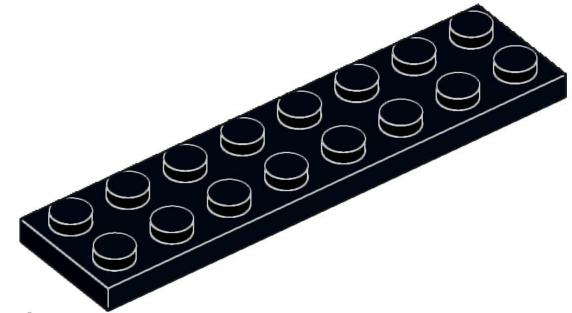

1x
3034
Black



2x
3009
Black

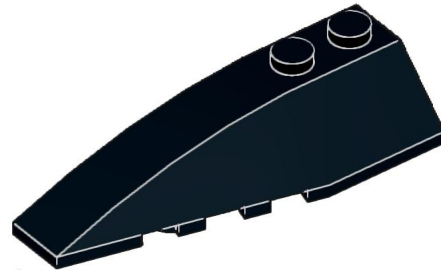

2x
41748
Black

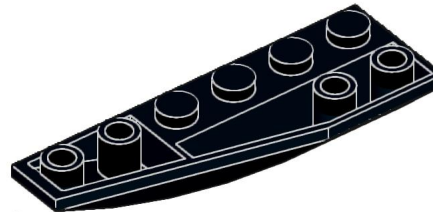

2x
41765
Black



1x
3036
Black

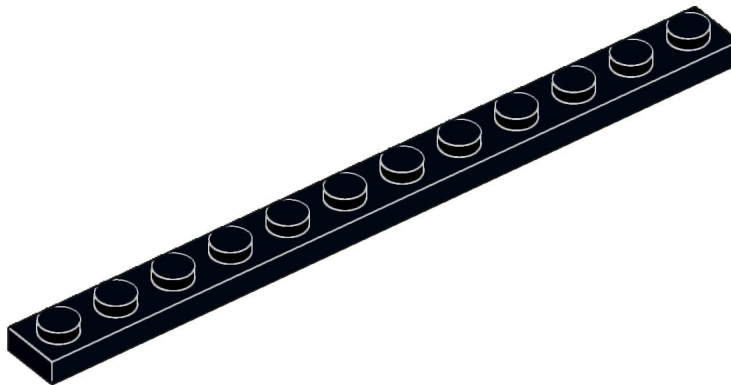

2x
60479
Black

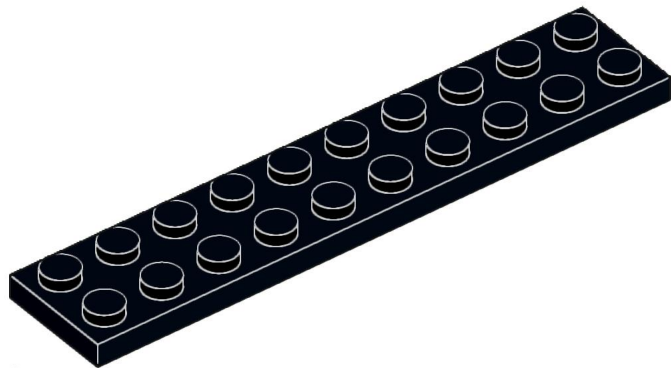

2x
3832
Black



1x
3028
Black



10x
98138
White



15x
25269
White

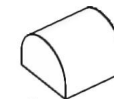

4x
49307
White



12x
22388
White

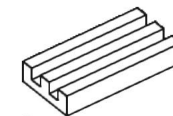

3x
2412b
White



1x
35480
White

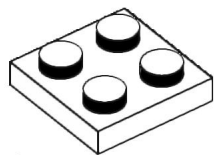

1x
3022
White

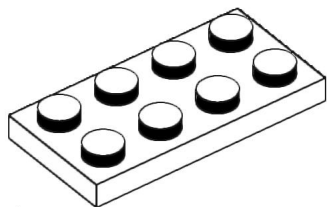

1x
3020
White

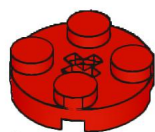

2x
4032
Red



2x
27925
White



1x
3070
Red

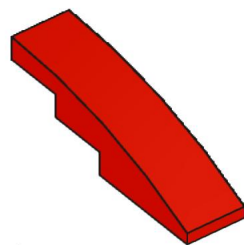

1x
61678
Red



2x
27263
White

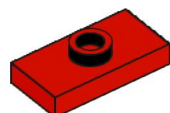

1x
3794b
Red



2x
98138pb385
Yellow



2x
18674
White

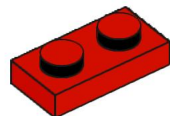

2x
3023
Red

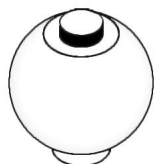

2x
20953
White

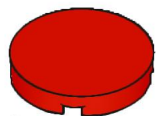

2x
4150
Red